



OPERATORS MANUAL

Midas
Klark Teknik Building,
Walter Nash Road,
Kidderminster.
Worcestershire.
DY11 7HJ.
England.

Tel:+44 1562 741515
Fax:+44 1562 745371

Email: midas.info@uk.telex.com
Website: midasconsoles.com

MIDAS Heritage 3000
Operators Manual DOC02-H3000
Issue 1.4 - July 2002

Due to a policy of continual product improvement, specification
and features may be subject to change without notice.



IMPORTANT SAFETY INSTRUCTIONS



These symbols are internationally accepted symbols that warn of potential hazards with electrical products.



The lightning flash with arrowhead symbol, within an equilateral triangle is intended to alert the user to the presence of uninsulated "dangerous voltage" within the product's enclosure that may be of sufficient magnitude to constitute a risk of electric shock to persons.



The exclamation point within an equilateral triangle is intended to alert the user to the presence of important operating and maintenance (servicing) instructions in the literature accompanying the appliance.

1. Read these instructions.
2. Keep these instructions.
3. Heed all warnings.
4. Follow all instructions.
5. Do not use this apparatus near water.
6. Clean only with a dry cloth.
7. Do not block any of the ventilation openings. Install in accordance with the manufacturers instructions.
8. Do not install near any heat sources such as radiators, heat registers, stoves, or other apparatus (including amplifiers) that produce heat.
9. Do not defeat the safety purpose of the polarized or grounding-type plug. A polarized plug has two blades with one wider than the other. A grounding type plug has two blades and a third grounding prong. The wide blade or the third prong are provided for your safety. If the provided plug does not fit into your outlet, consult an electrician for replacement of the obsolete outlet.
10. Protect the power cord from being walked on or pinched particularly at plugs, convenience receptacles, and the point where they exit from the apparatus.
11. Only use attachments / accessories specified by the manufacturer.
12.  Use only with the cart, stand, tripod, bracket, or table specified by the manufacturer, or sold with the apparatus. When a cart is used, use caution when moving the cart/apparatus combination to avoid injury from tip-over.
13. Unplug this apparatus during lightning storms or when unused for long periods of time.
14. Refer all servicing to qualified personnel. Servicing is required when the apparatus is damaged in any way, such as power-supply cord or plug is damaged, liquid has been spilled or objects have fallen into the apparatus, the apparatus has been exposed to rain or moisture, does not operate normally, or has been dropped.

KLARK TEKNIK GROUP

Walter Nash Road, Kidderminster, Worcestershire. DY11 7HJ. England

Tel: +44 1562 741515. Fax: +44 1562 745371

Company Registration No: 2414018

KLARK TEKNIK
SIGNAL PROCESSING BY DEFINITION

MIDAS
DESIGNED FOR A PURE PERFORMANCE

DECLARATION OF CONFORMITY

The Directive Covered by this Declaration

89/336/EEC Electromagnetic Compatibility Directive, amended by 92/31/EEC & 93/68/EEC

Equipment Type Product Name

Audio mixing console Heritage 3000

The Basis on which Conformity is being Declared

The Products named above comply with the requirements of the listed EU directives by meeting the following standards:

EN 55013: 1990

EN 50082: 1992

EN50081/1 and /2 Generic Standard using EN55022 Limits and Methods

EN55022 Class B Conduct Emissions

EN55022 Class B Radiated Emissions

EN61000-4-4 Fast Transient Burst Level 4

EN61000-4-2 Static Discharge Level 4

EN60204 Earth Continuity, Insulation at 500V

Signed:  Alex Cooper

Authority: Project Leader

Date: 1st April, 1999

Attention!

The attention of the specifier, purchaser, installer or user is drawn to special limitations of use which must be observed when these products are taken into service to maintain compliance with the above directives. Details of these special measures and limitations to use are available on request and are also contained in product manuals.

ATTENTION!

The following special limitations apply to the console and must be observed in order to maintain safety and electromagnetic compatibility performance:

POWER CONNECTION

The console should only be operated with the power supply connected to ground via its mains supply connector.

CONTROL CONNECTIONS

The console should only be operated with high quality screened control cables. All connector shells should be of metal construction so that they provide a screen when they are plugged into the console. All DEE connector shells should be connected to the cable screen. All XLR and DIN connectors should have pin 1 connected to the cable screen.

AUDIO CONNECTIONS

The console should only be operated with high quality screened twisted pair audio cables. All connector shells should be of metal construction so that they provide a screen when they are plugged into the console. All JACK connector shells should be connected to the cable screen. All XLR connectors should have pin 1 connected to the cable screen.

ELECTRIC FIELDS

If the console is operated in an electromagnetic field that is amplitude modulated by an audio frequency signal, the signal to noise ratio may be degraded. Degradation of up to 60dB may be experienced under extreme conditions (3V/m, 90% modulation).

INSTALLATION

There are a number of points to consider when installing a mixing console. Many of these points will have been addressed before the console is even unpacked but it is worth repeating them.

POSITION

The console should be located in a convenient space commensurate with the use to which the console is being put. Ideally a cool area is preferred not in close proximity to power distribution equipment or other potential sources of interference. Provision should be made for some flat surface surrounding the console to prevent people using it as a table top.

POWER

The power supply should be located as far from the console as the connecting cable will allow. It should be set for the appropriate line voltage and plugged into the mains outlet using the supplied cable.

***THE POWER SUPPLY SHOULD NEVER BE OPERATED
WITH THE MAINS EARTH DISCONNECTED***

Please note that the power supply contains LETHAL VOLTAGES greatly in excess of the mains voltage and that its rails can produce extremely large currents which could burn out equipment and wiring if shorted. All testing and servicing should ONLY be carried out by qualified engineers.

CONNECTORS

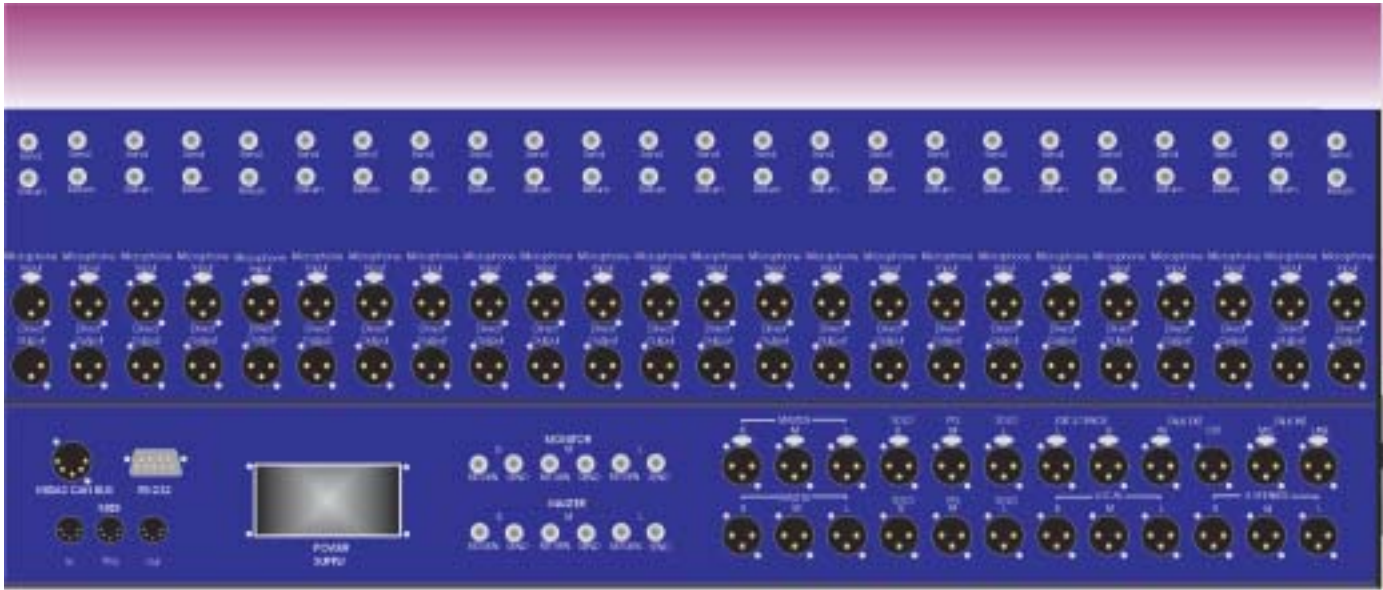

Input / Output XLR
 Pin 1: Ground
 Pin 2: Hot
 Pin 3: Cold

MIDI



THRU

OUT

IN

MIDI In

Pin 2: Ground
 Pin 4: In+
 Pin 5: In-

MIDI Thru

Pin 2: Ground
 Pin 4: In+
 Pin 5: In-

MIDI Out

Pin 2: Ground
 Pin 4: In+
 Pin 5: In-



RS-232

RS-232

Pin 2: Receive Data
 Pin 3: Transmit Data
 Pin 5: GND



CAN
 BUSS

Midas Can Bus

Pin 1: +18V (100mA max)
 Pin 2: Can low
 Pin 3: OV Can
 Pin 4: Can High
 Pin 5: -18V(100mA max)



Input Send / Return

Tip: Hot
 Ring: Cold
 Sleeve: Ground

Contents

Midas HS0001 Mono Input Module	Page 1
Midas HS0003 Input Fader	Page 2
Midas HS0004 Stereo Input Module	Page 8
Midas HS0003 Input Fader	Page 13
Midas HS0011 Group Module	Page 15
Midas HS0013 VCA Master Fader	Page 19
Midas HS0021 Master Module	Page 21
Midas HS0031 Monitor Module	Page 25
Midas HS0041 Matrix Module	Page 29
Midas Automation	Page 32
Heritage Menu Overview Ver 2.04	Page 40
Midas Can Bus Cable	Page 48
Heritage Back Panel	Page 49
Frame Dimensions	Page 51
Block Diagrams	
Input Module	Page 53
Group Module	Page 54
Matrix Module	Page 55
Master Module	Page 56
Monitor Module	Page 57
Heritage Overview and Statistics	Page 59
Heritage Technical Specifications	Page 61
Crib Sheet	

The 48V switch connects 48 volt phantom power to the input connector which is suitable for a condenser microphone or DI box.

The PAD switch gives 25dB of attenuation to the input signal which will allow the connection of high output microphones or line level signals. If the input amplifier is transformer coupled (option) the pad greatly reduces the risk of saturation at very low frequencies.

The PHASE switch activates a 180 degrees phase change within the input amplifier.

The PRE switch re configures the direct output to derive signal from the input channel pre insert and equaliser. It is important to note that pre insert direct outputs are also pre mute.

The treble FREQ control gives continuous adjustment of the frequency range that the treble equaliser acts on from 1k to 20k.

The treble BELL switch converts the treble equaliser from traditional MIDAS shelving response to full parametric operation.

The hi mid FREQ control gives continuous adjustment of the frequency range that the hi mid equaliser acts on from 400Hz to 8k.

The INS switch connects the input insert return signal to the input channel signal path.

The EQ switch connects the equaliser into the input channel signal path.

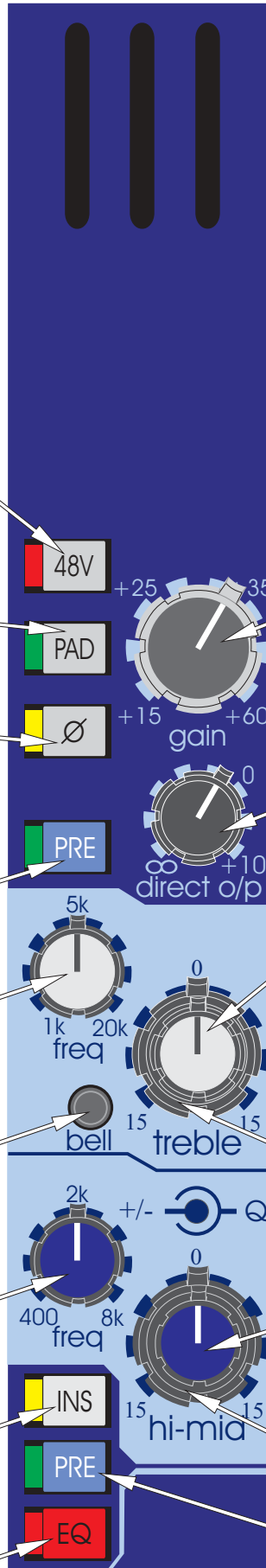

The GAIN control gives continuous adjustment of the input amplifier gain from + 15dB to + 60dB.

The DIRECT output control gives continuous adjustment of the direct output level from + 10dB to off. The output is derived from the input channel post equaliser pre fader signal.

The TREBLE (dual concentric top) control gives continuous adjustment of boost and cut from + 15dB to - 15dB with a 0dB centre detent.

The treble WIDTH (dual concentric bottom) control gives continuous adjustment of bandwidth from 0.1 to 2 octaves with a 0.5 octave centre detent. This only operates when the BELL switch is activated.

The HI MID (dual concentric top) control gives continuous adjustment of boost and cut from + 15dB to - 15dB with a 0dB centre detent.

The hi mid WIDTH (dual concentric bottom) control gives continuous adjustment of bandwidth from 0.1 to 2 octaves with a 0.5 octave centre detent.

The insert PRE switch arranges the input channel signal to pass through the insert point before the equaliser when activated and after the insert point when not activated.

The lo mid FREQ control gives continuous adjustment of the frequency range that the lo mid equaliser acts on from 100Hz to 2k.

The bass BELL switch converts the bass equaliser from traditional MIDAS shelving response to full parametric operation.

The bass FREQ control gives continuous adjustment of the frequency range that the bass equaliser acts on from 20Hz to 400Hz.

The HI PASS switch connects the filter in the input channel signal path before the insert point and equaliser.

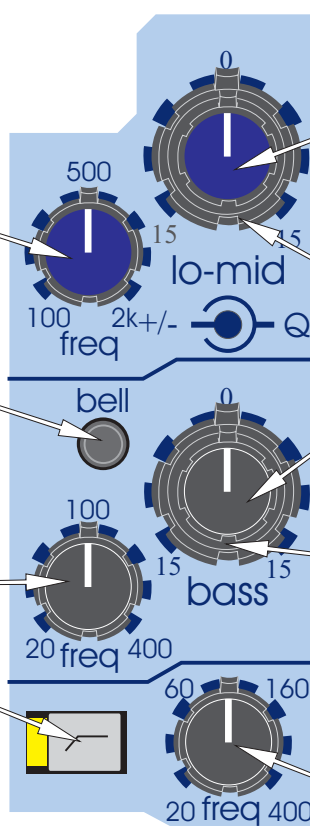

The LO MID (dual concentric top) control gives continuous adjustment of boost and cut from + 15dB to - 15dB with a 0dB centre detent.

The lo mid WIDTH (dual concentric bottom) control gives continuous adjustment of bandwidth from 0.1 to 2 octaves with a 0.5 octave centre detent.

The BASS (dual concentric top) control gives continuous adjustment of boost and cut from + 15dB to - 15dB with a 0dB centre detent.

The bass WIDTH (dual concentric bottom) control gives continuous adjustment of bandwidth from 0.1 to 2 octaves with a 0.5 octave centre detent.

This only operates when the BELL switch is activated.

The HI PASS filter control is continuously adjustable from 20Hz to 400Hz.

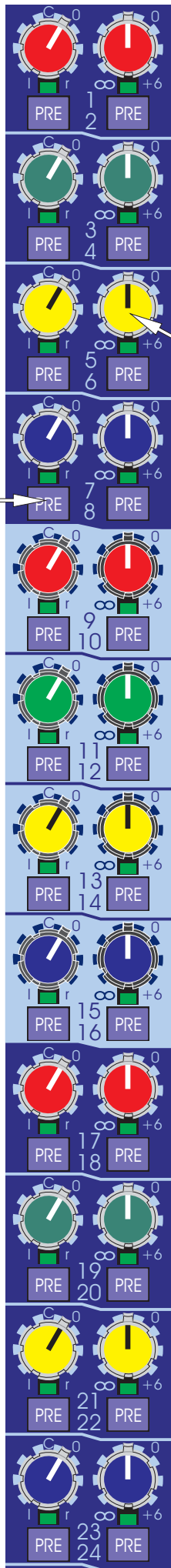

The aux PRE switches only operate when in one of the AUX bus modes; they change the signals sent to the group busses from post fader to pre fader. When configured as stereo auxes only the right switches are active.

The configurable group MIX controls (1 to 24) have two functions:-

- i. They operate as bus assign ON/OFF switches by way of a non latching push/push action with LED status indication.
- ii. They adjust the levels sent from the input channel to the group busses when in one of the AUX bus modes.

The group mix busses can be configured in three modes:- MONO AUX, STEREO AUX or POST PAN GROUP. This is controlled on a bus by bus basis by the global BUS MODE switches on the GROUP modules. When configured as mono auxes the left and right controls give independent level adjustments from + 6dB to off. When configured as stereo auxes the left controls perform a pan function with a constant power (- 3dB) law while the right controls give continuous level adjustment from + 6dB to off. When configured as stereo groups the level control functions are disabled such that any assigned busses are sent at unity gain from the channel post fader, post pan signals.

The PAN defaults to control the channel placement within a group or master stereo mix and has a constant power law i.e. - 3dB at the centre position.

The SIS switch enables the spatial imaging system which operates in conjunction with the pan and image controls. It also acts as a left, centre, right master bus enable overriding any stereo and mono master bus assignments.

When the spatial imaging system is active the IMAGE control can modify the action of the pan control so as to place the channel within a three speaker system. When the image control is fully clockwise the pan control will operate in full left, centre, right such that a centre panned signal will route to the centre speaker only and will not appear in either of the left or right outputs. When the image control is fully anti-clockwise the pan control reverts to stereo such that a centre panned signal will route at equal power to the left and right speakers. All other Image control positions generate a composite blend of the stereo and LCR panning systems so that the optimum degree of center image focus and speaker power can be obtained. When the image control and pan control are both set central the channel will be routed with equal power to all three speakers. Constant power is maintained at all times so that the image can be adjusted during the show without any perceived level change.

The ST switch connects the post fader channel signal to the master stereo bus via the pan control.

The MONO switch connects the post fader channel signal to the mono master bus.

The METER monitors the peak signal level of the pre fader input channel.

The MUTE switch mutes the input channel at all points after the insert send. The switch can be controlled from snapshot automation and by automute scenes.

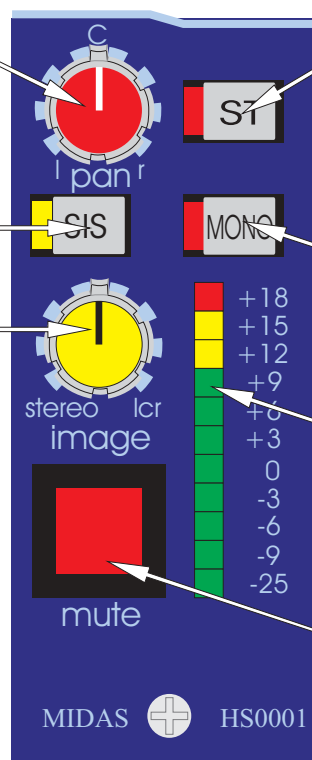

MIDAS HS0003

Input Fader

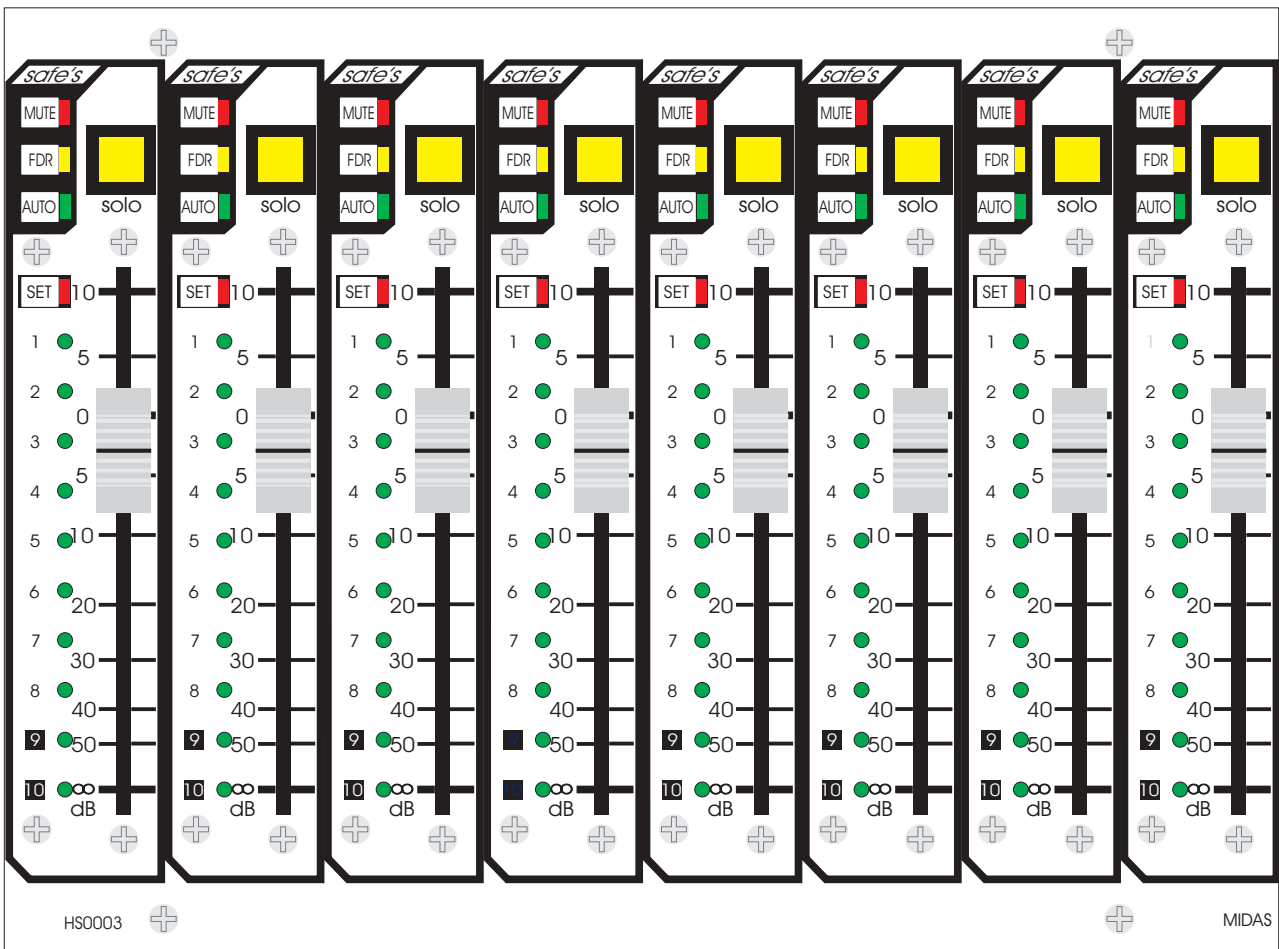

The SAFE switches disable remote control of the channels as follows:-

- i. The MUTE SAFE removes the channel mute from the snapshot automation and automute scenes.
- ii. The FADER SAFE removes the channel fader from the virtual fader automation and VCA master fader control including vca mutes.
- iii. The AUTO SAFE removes the channel from the snapshot automation system only; leaving the automutes, VCA masters and assignment systems active.

The SET switch is used to programme the channel automute and VCA master assignment. The central controller MODE and ASSIGN keys select the desired automute or VCA group and the SET switch will toggle the channel on and off with each alternate press.

The STATUS leds are used to show fader positions and the status of VCA and MUTE group assignments. The central controller MODE switches toggle through the four available states:- VCA group assignment, MUTE group assignment, FADER position manual recall and null, and full automated VIRTUAL FADER RECALL.

FADER MANUAL RECALL AND NULL
In this mode, the STATUS LEDs are used to prompt the operator where to move the fader. If the fader is not at the position stored in the current recalled snap shot, one/two LEDs will flash to indicate where the fader should be. A single flashing LED indicates that the fader should be positioned next to that LED, if two LEDs are flashing the fader should be between the two LEDs. As the fader is moved closer to the required position the LED(s) will stop flashing and will be replaced by a single continuously lit LED. Once the fader is at the correct position all LEDs will extinguish.

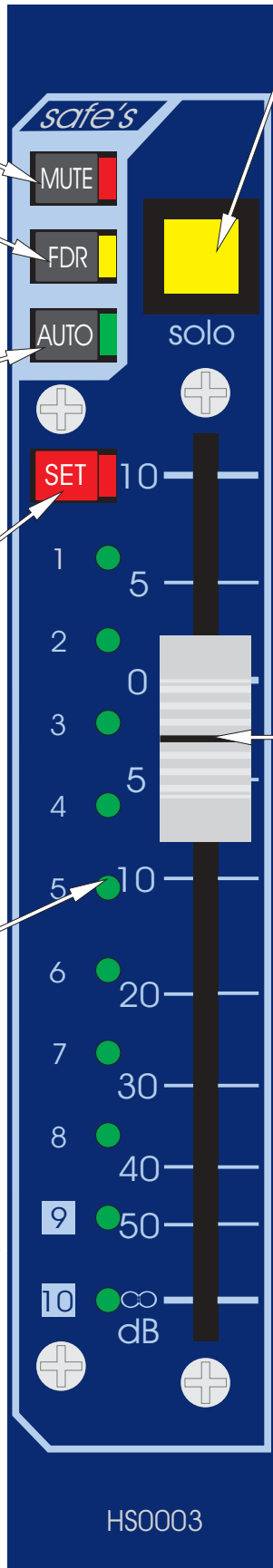

The SOLO switch sends the input channel signal to the PFL mono and AFL stereo busses. If the switch is pressed for a short time it will latch on or off, but if it is held on for more than 1 second the latching is disabled and when the switch is released the channel solo will turn off. As a default the solo system is auto cancelling so each new solo cancels the last. This function is time dependant which allows several solos to be active as long as they are switched on at approximately the same time. The SOLO ADD MODE switch on the MONITOR module defeats the auto cancelling and allows multiple channel monitoring. In this mode input solos have priority over outputs and will temporarily override any active output solos. The input solos also override any active VCA solos.

The FADER gives continuous adjustment of the input channel level from + 10dB to off.

FADER POSITION CHECK
When a scene's contents are being "checked" (see automation operation) the STATUS LEDs will indicate the fader position stored in the scene by continuously illuminating one or two LEDs as appropriate.

VIRTUAL FADER RECALL
When in VIRTUAL FADER mode (see automation operation) the automation system will generate a "virtual" fader, set to the level of the input fader at the time the snap shot was stored. The level of the virtual fader is added to the level of the physical input fader. In this mode the STATUS LEDs indicate the "position" of the virtual fader by illuminating a bar of LEDs starting at - .

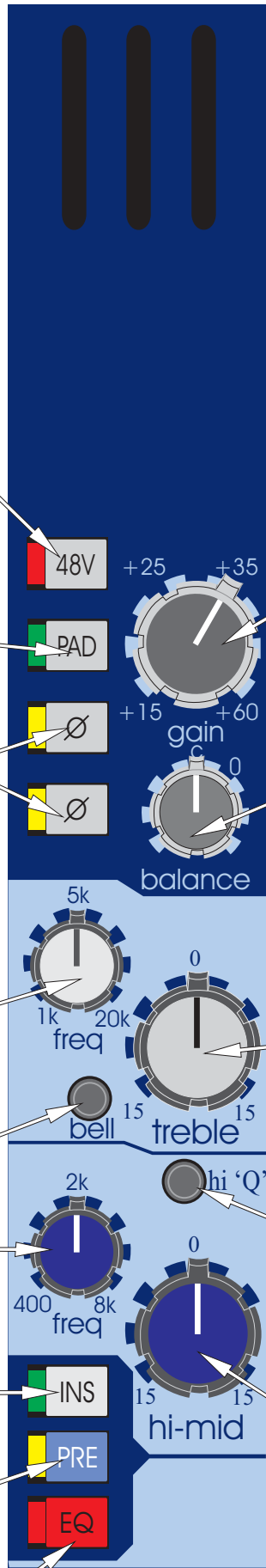

The 48V switch connects 48 volt phantom power to both input connectors and is suitable for condenser microphones or DI boxes.

The PAD switch gives 25dB of attenuation in both input signals to allow the connection of high output microphones or line level signals. If the input amplifiers are transformer coupled (option) the pad greatly reduces the risk of saturation at very low frequencies.

The PHASE switches activate a 180 degree phase change within the input amplifiers. The upper switch acts on the left channel and the lower switch acts on right channel.

The treble **FREQ** control gives continuous adjustment of the frequency range that the treble equalisers act on from 1k to 20k.

The treble **BELL** switch converts the treble equalisers from traditional MIDAS shelving response to bell filters with a 1.5 octave bandwidth.

The hi mid **FREQ** control gives continuous adjustment of the frequency range that the hi mid equalisers act on from 400Hz to 8k.

The **INS** switch connects the left and right input insert return signals to the input channel.

The insert **PRE** switch arranges the input channel signals to pass through the insert points before the equalisers when activated and after the insert points when not activated.

The **EQ** switch connects the left and right equalisers into the input channel signal paths.

The **GAIN** control gives continuous adjustment of the input amplifier gains from +15dB to +60dB.

The **BALANCE** control gives continuous and reciprocal adjustment of the stereo left and right signal levels by +10dB to -10dB. This allows fine adjustment of the left and right signal levels and imaging.

The **TREBLE** control gives continuous adjustment of left and right boost and cut from +15dB to -15dB with a 0dB centre detent.

The hi mid **HI Q** control changes the bandwidth of the hi mid equalisers from 1.5 octave to 0.5 octave.

The **HI MID** control gives continuous adjustment of left and right boost and cut from +15dB to -15dB with a 0dB centre detent.

The lo mid FREQ control gives continuous adjustment of the frequency range that the lo mid equalisers act on from 100Hz to 2k.

The bass BELL switch converts the bass equalisers from traditional MIDAS shelving response to bell filters with a 1.5 octave bandwidth.

The bass FREQ control gives continuous adjustment of the frequency range that the bass equalisers act on from 20Hz to 400Hz.

The HI PASS switch connects the filters in the input channel signal path before the insert points.

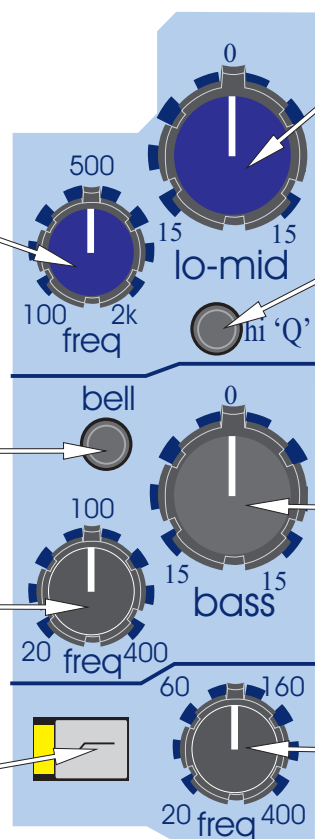

The LO MID control gives continuous adjustment of left and right boost and cut from +15dB to -15dB with a 0dB centre detent.

The lo mid HI Q control changes the bandwidth of the lo mid equalisers from 1.5 octave to 0.5 octave.

The BASS control gives continuous adjustment of the left and right shelving filters boost and cut from +15dB to -15dB with a 0dB centre detent.

The HI PASS filter control is continuously adjustable from 20Hz to 400Hz.

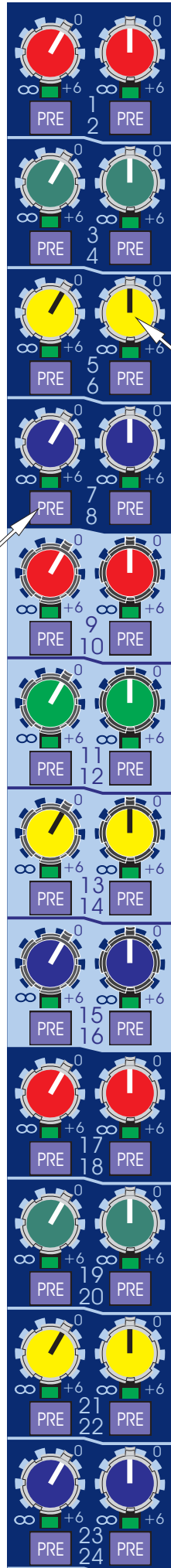

The aux PRE switches only operate when in one of the AUX bus modes; they change the signals sent to the group busses from post fader to pre fader.

The configurable group MIX controls (1 to 24) have two functions:-

- i. They operate as bus assign ON/OFF switches by way of a non latching push/push action with LED status indication.
- ii. They adjust the levels sent from the input channel to the group busses when in one of the AUX bus modes.

The group mix busses can be configured in three modes:- MONO AUX, STEREO AUX or POST PAN GROUP. This is controlled on a bus by bus basis by the global BUS MODE switches on the GROUP modules. When configured as mono auxes the left and right controls give independent level adjustments of the levels sent from a mono sum of the channels left and right sides. The adjustment is from +6dB to off. When configured as stereo auxes the left controls give level adjustment of the left channel signal levels and the right controls give level adjustment of the right channel signal levels. When configured as stereo groups the level control functions are disabled such that any assigned busses are sent at unity gain from the channel post fader, post pan signals.

The left and right PAN controls are used to place the input channel signals within a stereo group or stereo master mix. As well as image placement, the controls can also adjust the image width from stereo through mono to reverse stereo (left and right crossed over). The controls have a constant power law i.e. -3dB at the centre position.

The ST switch connects the post fader channel signals to the stereo master bus via the pan controls.

The MUTE switch mutes the input channel at all points after the insert send. The switch can be controlled from snapshot automation and by automute scenes.

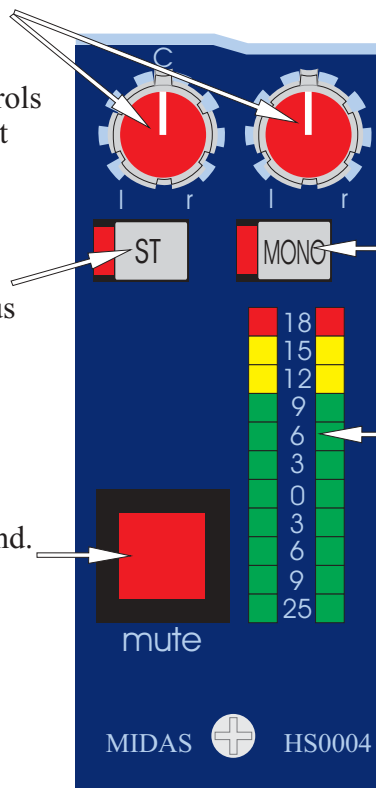

The MONO switch connects the post fader channel signals to the mono master bus.

The METERS monitor the pre fader peak signal levels of input channel.

MIDAS HS0003

Input Fader

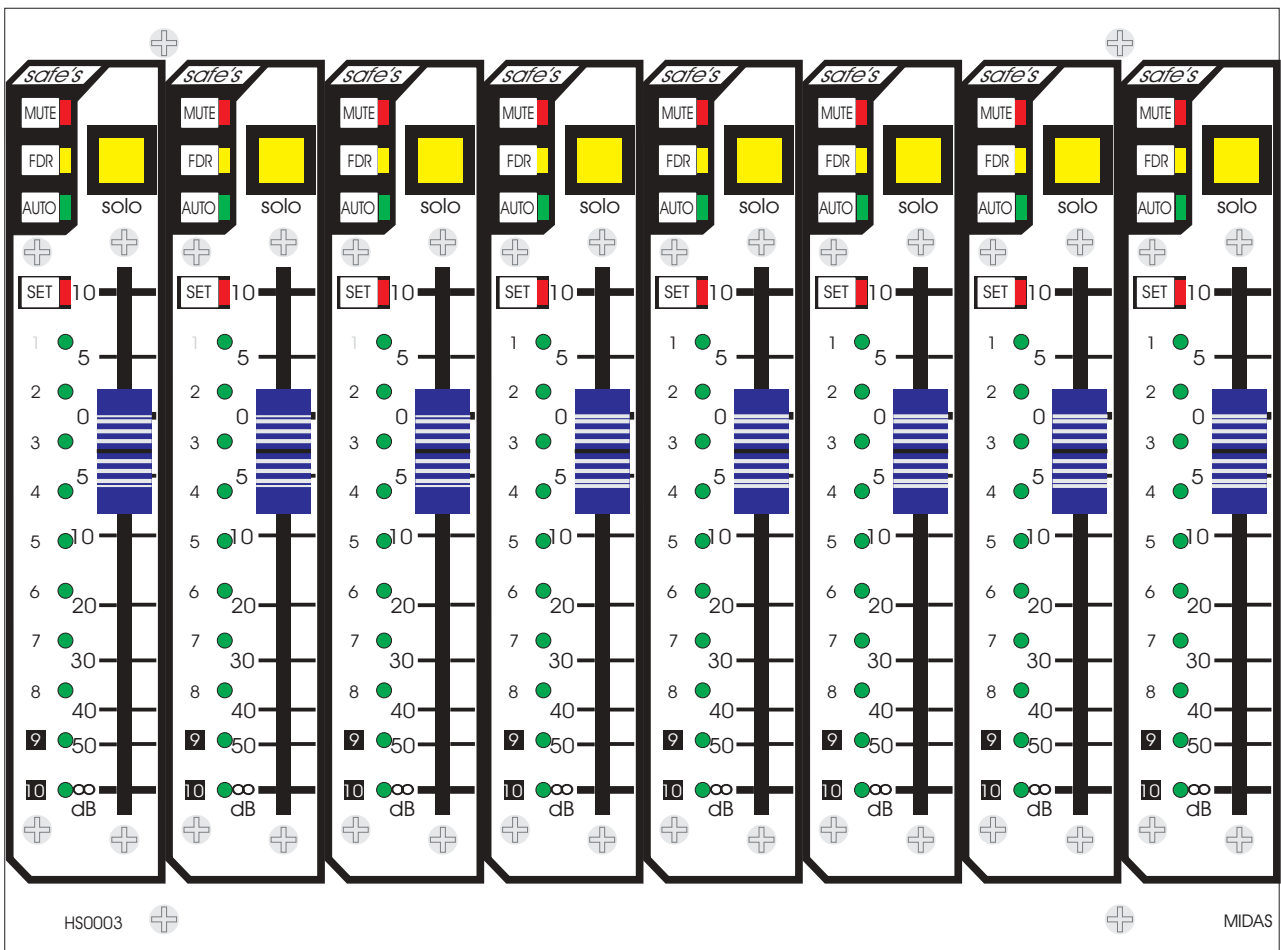

The SAFE switches disable remote control of the channels as follows:-

- i. The MUTE SAFE removes the channel mute from the snapshot automation and automute scenes.
- ii. The FADER SAFE removes the channel fader from the virtual fader automation and VCA master fader control including vca mutes.
- iii. The AUTO SAFE removes the channel from the snapshot automation system only; leaving the automutes, VCA masters and assignment systems active.

The SET switch is used to programme the channel automute and VCA master assignment. The central controller MODE and ASSIGN keys select the desired automute or VCA group and the SET switch will toggle the channel on and off with each alternate press.

The STATUS leds are used to show fader positions and the status of VCA and MUTE group assignments. The central controller MODE switches toggle through the four available states:- VCA group assignment, MUTE group assignment, FADER position manual recall and null, and full automated VIRTUAL FADER RECALL.

FADER MANUAL RECALL AND NULL
 In this mode, the STATUS LEDs are used to prompt the operator where to move the fader. If the fader is not at the position stored in the current recalled snap shot, one/two LEDs will flash to indicate where the fader should be. A single flashing LED indicates that the fader should be positioned next to that LED, if two LEDs are flashing the fader should be between the two LEDs. As the fader is moved closer to the required position the LED(s) will stop flashing and will be replaced by a single continuously lit LED. Once the fader is at the correct position all LEDs will extinguish.

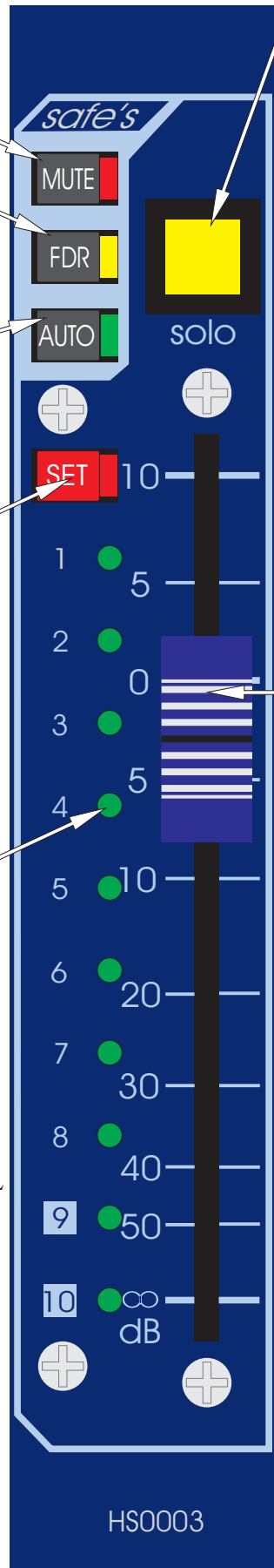

The SOLO switch sends the input channel signal to the PFL mono and AFL stereo busses. If the switch is pressed for a short time it will latch on or off, but if it is held on for more than 1 second the latching is disabled and when the switch is released the channel solo will turn off. As a default the solo system is auto cancelling so each new solo cancels the last. This function is time dependant which allows several solos to be active as long as they are switched on at approximately the same time. The SOLO ADD MODE switch on the MONITOR module defeats the auto cancelling and allows multiple channel monitoring. In this mode input solos have priority over outputs and will temporarily override any active output solos. The input solos also override any active VCA solos.

The FADER gives continuous adjustment of the input channel level from + 10dB to off.

FADER POSITION CHECK
 When a scene's contents are being "checked" (see automation operation) the STATUS LEDs will indicate the fader position stored in the scene by continuously illuminating one or two LEDs as appropriate.

VIRTUAL FADER RECALL
 When in VIRTUAL FADER mode (see automation operation) the automation system will generate a "virtual" fader, set to the level of the input fader at the time the snap shot was stored. The level of the virtual fader is added to the level of the physical input fader. In this mode the STATUS LEDs indicate the "position" of the virtual fader by illuminating a bar of LEDs starting at - .

MIDAS HS0011 Group Module

The diagram shows the front panel of the MIDAS HS0011 Group Module, organized into several functional sections:

- Level Indicators:** Two vertical level meters at the top, labeled 'l' (left) and 'r' (right). The scales range from +21 to -36 dB. A legend indicates 'green = stereo aux' and 'red = mono aux'.
- Direct Inputs:** Two rotary switches labeled 'direct inputs' with positions for '∞', '+10', and '0'. Below each switch are two level meters and buttons for 'PRE', 'insert', 'MUTE', and 'SOLO'.
- Input Channels:** Eight pairs of rotary switches, numbered 1 through 8. Each pair has positions for '∞', '+6', and '0'. Below each pair are two level meters and buttons for 'PRE', 'insert', 'MUTE', and 'SOLO'.
- Matrix:** A section with two rotary switches and buttons for 'PRE', 'insert', and 'MUTE'.
- VCA:** Two rotary switches labeled 'vca' with positions for '9' and '10'.
- to masters:** A section with buttons for 'ST', 'MONO', 'pan', 'TALK', 'INS', 'mute', 'SAFE', and 'SOLO split'.
- Group Level:** Two large level meters at the bottom, labeled 'solo' and 'group'. The scales range from -10 to -∞ dB.

MIDAS HS0011

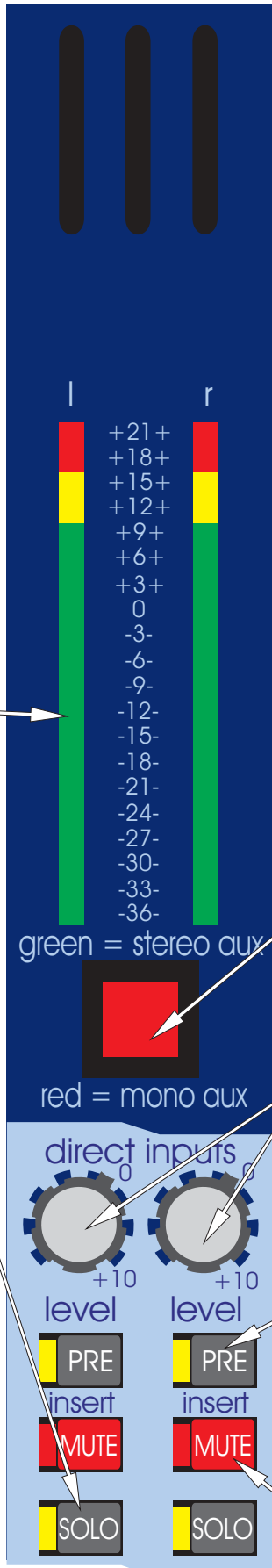

The METERS monitor the peak signal levels of the sub group outputs (post fader).

The direct SOLO switches send direct input to the PFL mono and AFL stereo busses (AFL is selected as stereo or mono depending on the group SPLIT switch settings). If a SOLO switch is pressed for a short time it will latch on or off, but, if it is held on for more than 1 second the latching is disabled and when the switch is released the solo will turn off. As a default the solo system is auto cancelling so each new solo cancels the last. This function is time dependant which allows several solos to be active as long as they are switched on at approximately the same time, i.e. to solo both sides of a stereo mix press both solo switches at the same time. Alternatively the SOLO ADD MODE switch on the MONITOR module can be used to defeat the auto cancelling and allow multiple channel monitoring. In this mode input channel solos have priority over all other solos and will temporarily override them.

The global BUS MODE switches configure input module MIX controls to act as either mono aux (level and level), stereo aux (level and pan) or as audio sub groups (post fader and main pan). This makes the console extremely flexible and quick to reconfigure.

The DIRECT input controls give continuous adjustment of the direct input levels from + 10dB to off. The direct signals are summed into the sub group signals and can be used as effects returns etc. or for console bus linking.

The direct PRE switches move the point at which the direct signals are summed into the sub groups. The default is post insert but when the PRE switches are active the signals are summed at the sub group mix busses.

The direct MUTE switches mute the sub group direct inputs at all points.

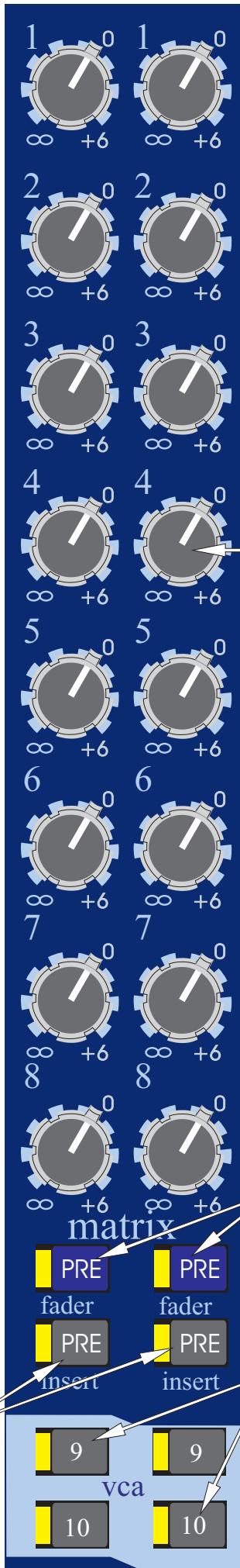

The matrix MIX controls (1 to 8) give continuous adjustment of the sub group levels sent to the matrix mixes from +6dB to off.

The PRE fader switches change the signals sent to the matrix mixes from post group fader to pre group fader.

The PRE insert switches change the signals sent to the matrix mixes from post group insert to pre group insert and override the pre fader switches. It is important to note that pre insert matrix sends are also pre the group mutes.

The VCA switches assign the audio sub groups to VCA control from VCA masters 9 and 10.

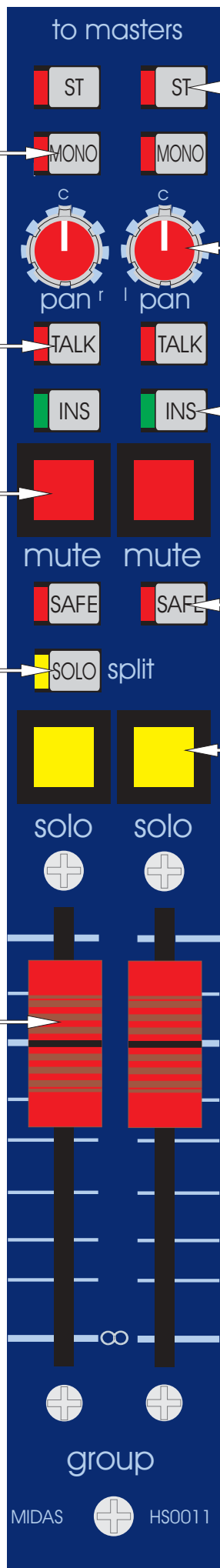

The MONO switches connect the post fader sub group signals to the mono master bus.

The TALK switches connect the sub groups to the MONITOR module. When the TALK INTERNAL or GENERATOR INTERNAL are active on the MONITOR module the oscillator, pink noise and talk mic can be routed to the sub groups.

The MUTE switches mute the sub group signals at all points after the insert send. The switches can be controlled from snapshot automation.

The SPLIT switch changes the sub group AFL solos from mono to stereo.

The GROUP FADERS give continuous adjustment of the sub group output levels from +10dB to off.

The ST switches connect the post fader sub group signals to the stereo master stereo busses via the pan controls.

The group PAN controls place the sub groups within the stereo master mix and have a constant power law i.e. -3dB at the centre position.

The INS switches connect the group insert return signals to the sub group signals.

The mute SAFE removes the channel mute from snapshot automation.

The SOLO switches send sub group signals to the PFL mono and AFL stereo busses. If a SOLO switch is pressed for a short time it will latch on or off, but, if it is held on for more than 1 second the latching is disabled and when the switch is released the channel solo will turn off. As a default the solo system is auto cancelling so each new solo cancels the last. This function is time dependant which allows several solos to be active as long as they are switched on at approximately the same time, i.e. to solo both sides of a stereo mix press both solo switches at the same time. Alternatively the SOLO ADD MODE switch on the MONITOR module can be used to defeat the auto cancelling and allow multiple channel monitoring. In this mode input channel solos have priority over the sub group solos and will temporarily override them. When the input solos are cancelled the mix group solos will be active again. Sub group solos can also be temporarily overridden by activating the corresponding direct input solos.

MIDAS HS0013

VCA Master Fader

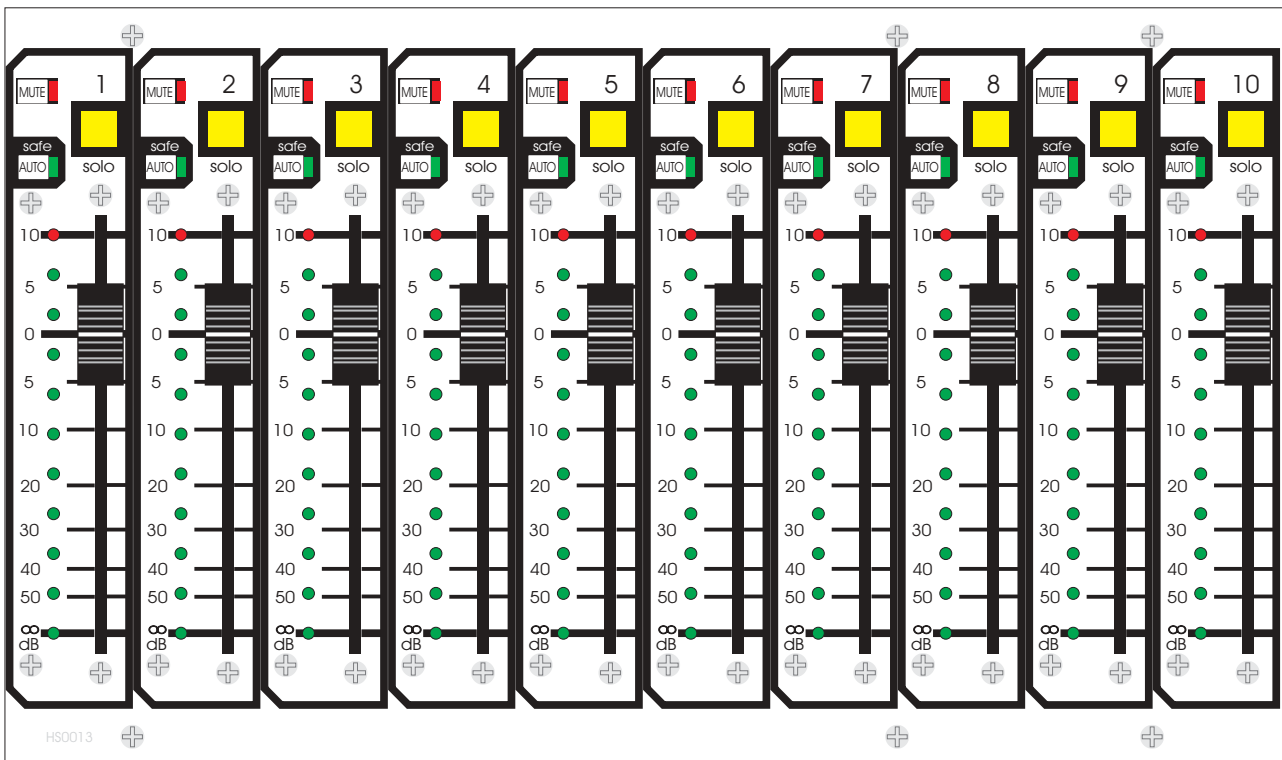

The vca MUTE switches act on any post fader input channels or audio sub groups which are assigned to be controlled from the corresponding VCA masters. The switches can be controlled from snapshot automation.

The AUTO SAFE switches disable snapshot automation control of the VCA master faders and VCA mutes.

The STATUS LEDs are off when the console is in VCA or mute assignment modes (see assignment operation). When the console is in FADER mode indication the STATUS LED's can indicate one of three states: -

FADER MANUAL RECALL AND NULL
 In this mode, the STATUS LEDs are used to prompt the operator where to move the fader. If the fader is not at the position stored in the current recalled snap shot, one/two LEDs will flash to indicate where the fader should be. A single flashing LED indicates that the fader should be positioned next to that LED, if two LEDs are flashing the fader should be between the two LEDs. As the fader is moved closer to the required position the LED(s) will stop flashing and will be replaced by a single continuously lit LED. Once the fader is at the correct position all LEDs will extinguish.

FADER POSITION CHECK
 When a scene's contents are being "checked" (see automation operation) the STATUS LEDs will indicate the fader position stored in the scene by continuously illuminating one or two LEDs as appropriate.

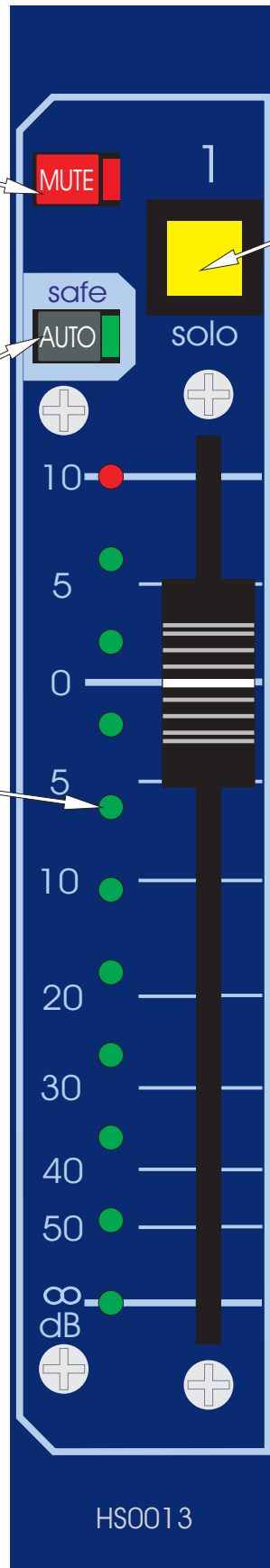

The vca SOLO switches are used to monitor the VCA master faders by creating a mix on the solo busses which consists of all input channels and audio sub groups which are assigned to control from the corresponding VCA masters. If a VCA solo switch is pressed for a short time it will latch on or off, but if it is held on for more than 1 second the latching is disabled and when the switch is released the solo will turn off. When the console is operating in SOLO ADD MODE input channels have priority over VCA solos and will temporarily override them.

VIRTUAL FADER RECALL
 When in VIRTUAL FADER mode (see automation operation) the automation system will generate a "virtual" fader, set to the level of the input fader at the time the snap shot was stored. The level of the virtual fader is added to the level of the physical input fader. In this mode the STATUS LEDs indicate the "position" of the virtual fader by illuminating a bar of LEDs starting at - .

MIDAS HS0021 Masters Module

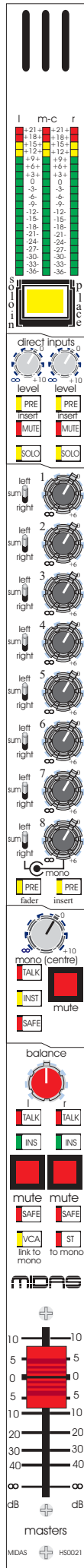

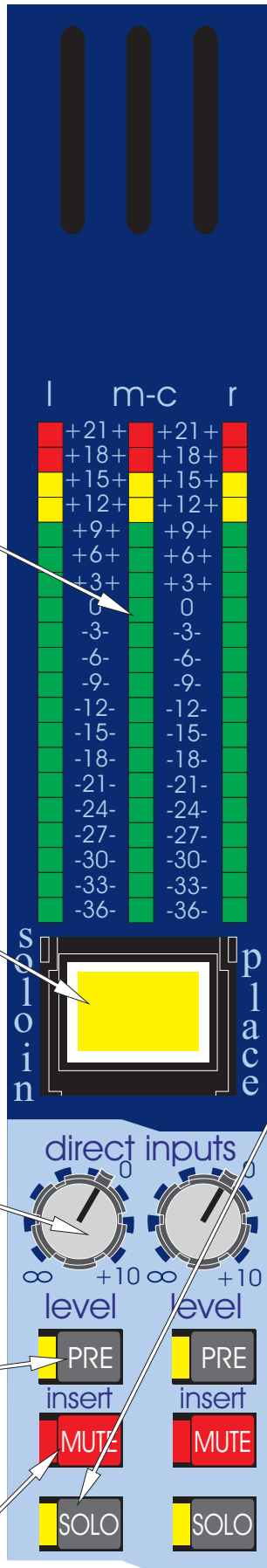

The METERS monitor the peak signal levels of the three master outputs (post fader).

The SOLO IN PLACE switch sets the console to solo in place mode. In this mode any input solo that is pressed activates a mute of all the other channels. The mute safe switches on the input channels can be used to protect channels from this function if desired.

The DIRECT input controls give continuous adjustment of the direct input levels from + 10dB to off. The direct signals are summed into the master left and right signals and can be used as effects returns etc. or for console bus linking. The master mono also has a direct input XLR on the rear of the console for which is intended for console linking only.

The direct PRE switches move the point at which the direct signals are summed into the masters. The default is post insert but when the PRE switches are active the signals are summed at the master mix busses.

The direct MUTE switches mute the master direct inputs at all points.

The direct SOLO switches send direct input to the PFL mono and AFL stereo busses. If a SOLO switch is pressed for a short time it will latch on or off, but, if it is held on for more than 1 second the latching is disabled and when the switch is released the solo will turn off. As a default the solo system is auto cancelling so each new solo cancels the last. This function is time dependant which allows several solos to be active as long as they are switched on at approximately the same time, i.e. to solo both sides of a stereo mix press both solo switches at the same time. Alternatively the SOLO ADD MODE switch on the MONITOR module can be used to defeat the auto cancelling and allow multiple channel monitoring. In this mode input channel solos have priority over all other solos and will temporarily override them.

The matrix STEREO switches select the source for the lower matrix mix controls as either left channel, right channel or a sum of both.

The PRE fader switches change the signals sent to the matrix mixes from post group fader to pre group fader.

The MONO level control gives continuous adjustment of the mono master output level from +10dB to off.

The mono TALK switch connect the mono master to the MONITOR module. When the TALK INTERNAL or GENERATOR INTERNAL are active on the MONITOR module the oscillator, pink noise and talk mic can be routed to the mono master outputs.

The mono INST switch connects the mono insert return signals to the mono master signals.

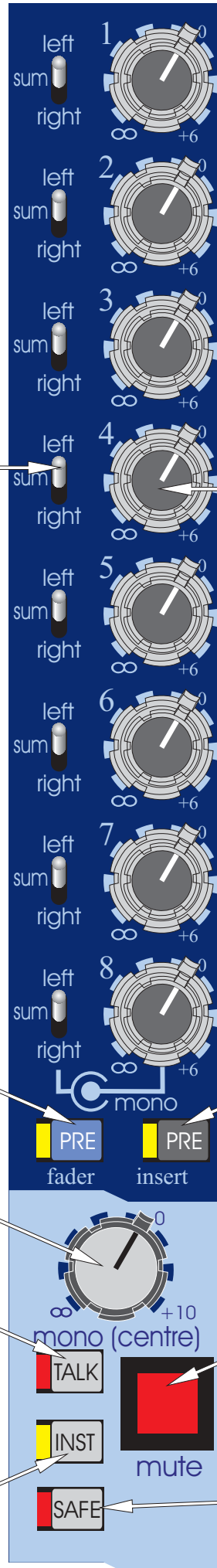

The matrix MIX controls (1 to 8) give continuous adjustment of the master levels sent to the matrix mixes from +6dB to off. The top control adjusts the feed from the mono master and the lower control adjusts the feed from the stereo masters.

The PRE insert switches change the signals sent to the matrix mixes from post group insert to pre group insert and override the pre fader switches. It is important to note that pre insert matrix sends are also pre the master mutes.

The MUTE switch mutes the mono master signals at all points after the insert send. The switch can be controlled from snapshot automation.

The mono mute SAFE removes the mono mute from snapshot automation.

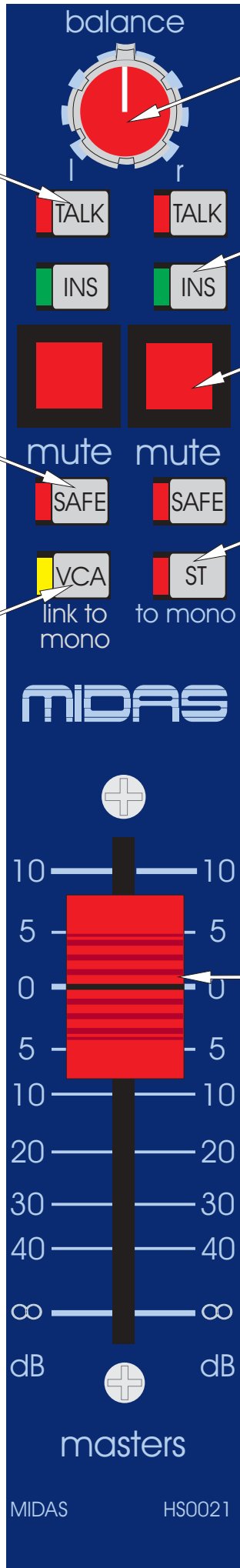

The TALK switches connect the stereo masters to the MONITOR module. When the TALK INTERNAL or GENERATOR INTERNAL are active on the MONITOR module the oscillator, pink noise and talk mic can be routed to the stereo masters.

The mute SAFE switches remove the stereo master mutes from snapshot automation.

The VCA link to mono switch connects the mono master level control to the stereo master fader so that the mono output tracks any change of the stereo master fader.

The BALANCE (pan) control gives continuous and reciprocal adjustment of the stereo left and right signal levels by + 3dB to off. This allows fine adjustment of the left, right power levels and imaging.

The INS switches connect the master insert return signals to the stereo master signals.

The MUTE switches mute the stereo master signals at all points after the insert send. The switches can be controlled from snapshot automation.

The STEREO to mono switch connects a mono sum of the pre insert stereo master signals to the mono master bus.

The MASTER FADER gives continuous adjustment of the stereo master output levels from + 10dB to off.

MIDAS HS0031 Monitor Module

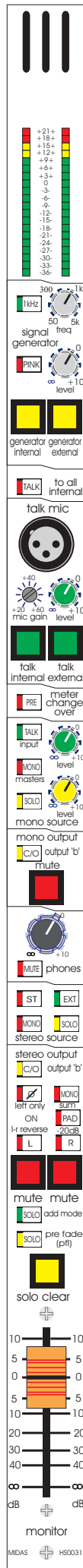

The METERS monitor the peak signal levels of the stereo left and right monitor paths.

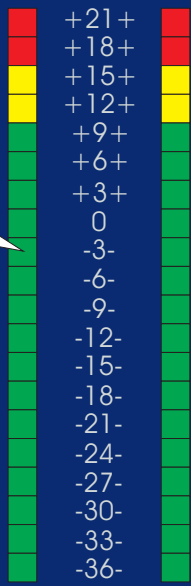

The 1kHz switch overrides the swept frequency control giving a fixed 1k tone.

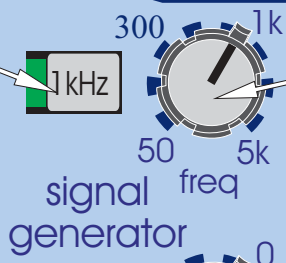

The **FREQ.** control gives continuous adjustment of the oscillator frequency from 50Hz to 5k.

The PINK switch overrides the oscillator by giving a pink noise output.



The generator **LEVEL** control gives continuous adjustment of the signal generator peak output signals from +10dBu to off.

The **GENERATOR TO INTERNAL** switch connects the signal generator output to the console's internal talk all and talk select busses.

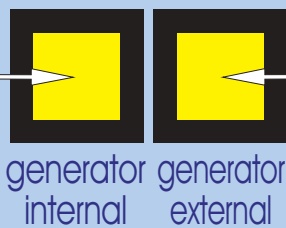

The **GENERATOR TO EXTERNAL** switch connects the signal generator output to the talk external output XLR.

The **TALK TO ALL** switch overrides all output talk switches so that the generator or talk mic can be routed to ALL OUPUTS



The TALK XLR socket accepts balanced 150 microphone signals.

The MIC GAIN preset gives continuous adjustment of the microphone amplifier gain from +20dB to +60dB and operates in conjunction with a peak limiter which is factory set to +10dBu.

The TALK TO INTERNAL switch connects the talk mic output to the console's internal talk system and at the same time dims all the local outputs by 20dB to prevent howl round.

The TALK input routes the talk external input to the mono local monitor output.

The MONO masters switch routes the post fader mono master mix to the mono local monitor output.

The SOLO switch routes solo signals to the mono local monitor output when ever a solo is active on the console. This overrides any signals sent from the mono master but does not override talk inputs.

The mono output "b" C/O switch disconnects the mono local monitor output from the main "a" output and re-routes it to the secondary "b" output.

The phones MUTE switch mutes the headphone outputs.

The ST master switch routes the post fader stereo master mix to the stereo local monitor outputs.

The MONO master switch routes the post fader mono master mix to the stereo local monitor outputs.

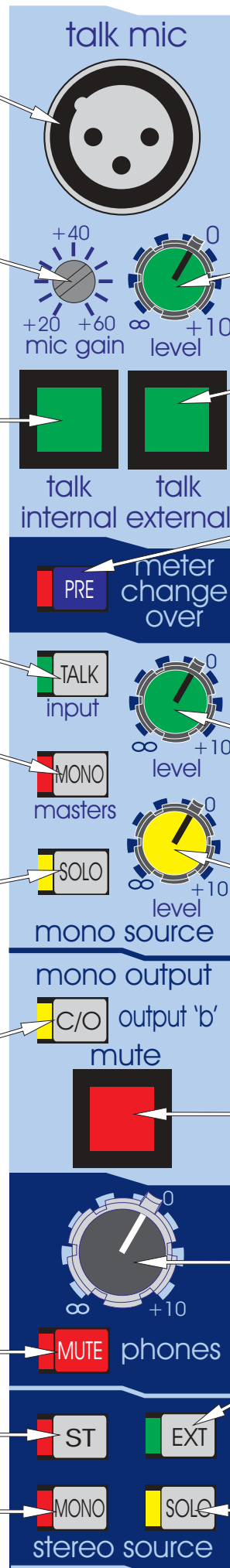

The talk LEVEL gives continuous adjustment of the post limiter signals from +10dB to off.

The TALK TO EXTERNAL switch connects the talk mic output to the talk external output XLR.

The PRE meter change over switch changes the operation of every meter on the console (except the monitor meters). The "normal" meter operation is to monitor pre fader on input channels and post fader on all other signals. When the pre meter change over is active the meters change to monitor input amplifiers or bus amplifiers (as appropriate) on all signals.

The talk LEVEL gives continuous adjustment of the external talk input from +10dB to off.

The talk LEVEL gives continuous adjustment of the external talk input from +10dB to off.

The mono output MUTE switch mutes the mono local monitor output.

The PHONES level control gives continuous adjustment of the headphone level from + 10dB to off.

The EXT switch routes the stereo external input (2 track return etc.) to the stereo local monitor outputs.

The SOLO switch routes solo signals to the stereo local monitor outputs when ever a solo is active on the console. This overrides any signals sent from the stereo master, mono master or external input.

The stereo output "b" C/O switch disconnects the stereo local monitor outputs from the main "a" outputs and re-routes them to the secondary "b" outputs.

The PHASE switch reverses the phase of the left hand monitor signal.

When the left/right reverse is ON the left hand monitor signals are routed onto the right channel output speakers and the right hand monitor signal are routed onto the left channel output speakers.

The LEFT switch routes left hand monitor signal to both the left and right local monitor speaker outputs.

The left MUTE switch controls the mute function on the left hand side of the stereo local monitor speaker outputs.

The SOLO PFL switch sends the mono PFL solo bus signals to the headphones and local monitor outputs in place of the stereo AFL solo bus signals.

The SOLO ON / CLEAR switch and indicator has two functions; it illuminates when any solo switch is active and when pressed it clears any active solo switches.

The MONITOR fader gives continuous adjustment of all three local monitor output levels from +10dB to off.

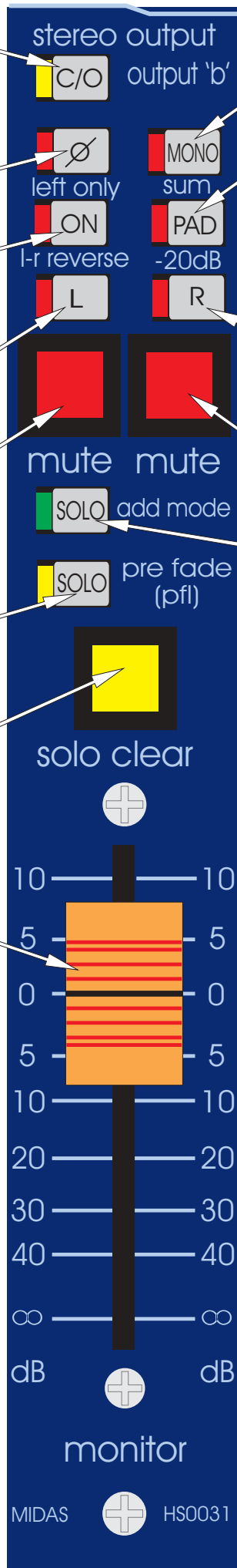

The MONO sum switch adds the left and right monitor signals with a 4.5dB summing loss.

The -20 PAD switch acts on all three local monitor outputs causing them to dim by 20dB. This function is also activated whenever the talk system is in use to prevent howl round.

The RIGHT switch routes right hand monitor signal to both the left and right local monitor speaker outputs.

The right MUTE switch controls the mute function on the right hand side of the stereo local monitor speaker outputs.

The SOLO ADD MODE switch allows multiple channel access to the solo busses. When the solo add mode is off the action of pressing a solo switch will cancel any previously active solo. Multiple solos such as stereo left and right signals can be monitored in this mode of operation as long as the solo switches are pressed at approximately the same time. When the solo add mode is on the auto cancelling is defeated which allows multiple channel or output soloing. In this mode input solos have priority over output solos and VCA solos and will temporarily override them. When the input solo is cancelled the output solos or VCA solos will return.

MIDAS HS0041 Matrix Module

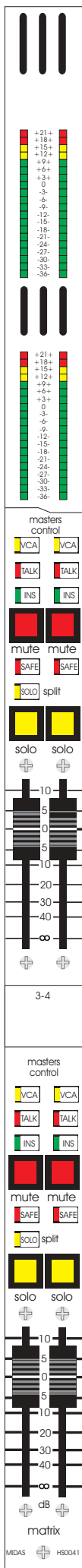

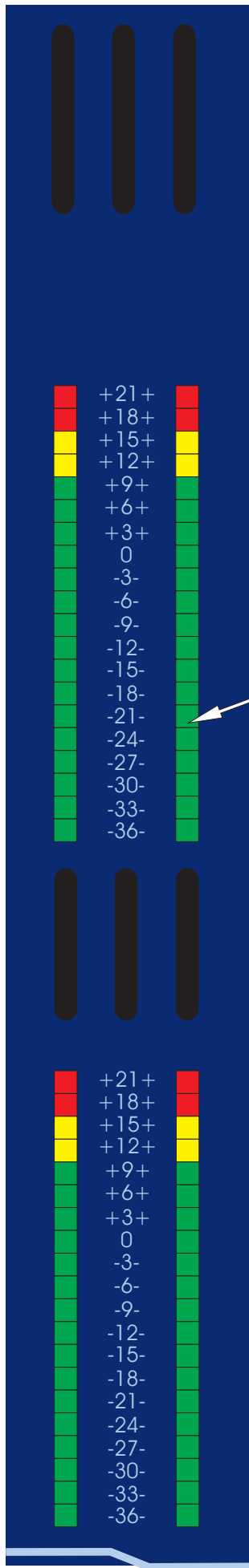

The METERS monitor the peak signal levels of the matrix outputs (post fader).



The VCA switches assign the matrix outputs to VCA control from the MASTER module fader.

The INS switches connect the matrix insert return signals to the matrix mixes.

The mute SAFE switches remove the matrix mutes from snapshot automation.

The SPLIT switch changes the matrix AFL solos from mono to stereo.

The MATRIX faders give continuous adjustment of the matrix output levels from +10dB to off.

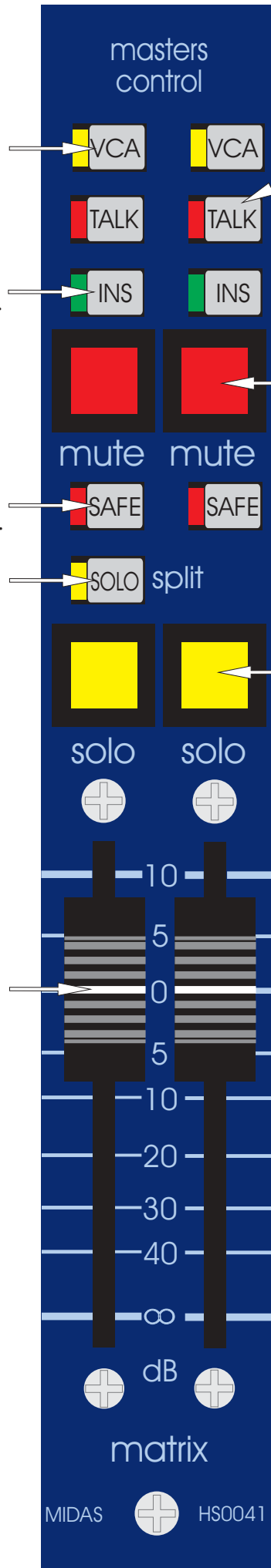

The TALK switches connect the matrix mixes to the MONITOR module. When the TALK INTERNAL or GENERATOR INTERNAL are active on the MONITOR module the oscillator, pink noise and talk mic can be routed into the matrix mixes.

The matrix MUTE switches mute the matrix signals at all points after the insert send. The switches can be controlled from snapshot automation.

The SOLO switches send matrix signals to the PFL mono and AFL stereo busses. If a SOLO switch is pressed for a short time it will latch on or off, but, if it is held on for more than 1 second the latching is disabled and when the switch is released the channel solo will turn off. As a default the solo system is auto cancelling so each new solo cancels the last. This function is time dependant which allows several solos to be active as long as they are switched on at approximately the same time, i.e. to solo both sides of a stereo mix press both solo switches at the same time. Alternatively the SOLO ADD MODE switch on the MONITOR module can be used to defeat the auto cancelling and allow multiple channel monitoring. In this mode input channel solos have priority over the matrix solos and will temporarily override them. When the input solos are cancelled the matrix solos will be active again.

Automation

The diagram illustrates a control panel for automation, organized into several functional sections:

- assign keys:** A vertical column on the left containing a plus sign (+) at the top, followed by ten numbered buttons (1-10) with red and green indicators, and another plus sign (+) at the bottom.
- mode switches:** A section containing four large square buttons labeled "lock" (red), "vca" (yellow), "mute" (red), and "fader" (green). Below these is a section for "virtual fader recall mode" with a red button and two small circular buttons labeled "a" (green) and "b" (black).
- Numbered Row:** A central row of ten buttons, each with a number (1-10) and a red-to-green gradient bar. The letters "a" through "s" are positioned to the left and right of the buttons, forming the word "automation" across the row.
- automation system:** A large section on the right containing:
 - A 3x3 grid of function buttons: "store" (red), "midi" (yellow), "system" (yellow), "insert" (yellow), "delete" (red), "copy" (green), "check" (yellow), "cancel" (red), "confirm" (green).
 - A row of four buttons with a white icon on a black background, labeled "act" and "scene".
 - A row of three yellow buttons labeled "act/scene c/o", "down", and "up".
 - A row of three buttons labeled "last" (red), "now" (yellow), and "next" (green).

Plus signs (+) are also present at the top center and bottom center of the panel area.

Assignment Control

The LOCK switch will toggle state each time it is pressed. When the LOCK switch is illuminated all assignment changes are disabled and virtual fader operation is locked (either on or off). The console will automatically revert to a locked state if no assignment controls are operated within a 90 second period.

The VCA, MUTE and FADER switches set the current assignment/display mode for the fader tray LED's. As a default these switches interlock so that only one mode can be viewed at a time. However if Mute and VCA are pressed down for more than 0.5 second the interlock is removed. This is used for "clear mode" (see below).

If the console is in VCA or MUTE mode, the ASSIGN KEYS can be used to change settings for input VCA assignment or automute assignment in conjunction with the SET switch on each channel as follows:-

To enter ASSIGNMENT mode first press the LOCK switch (to un-lock the assignment system).

Press the ASSIGN KEYS to set up the required group number or numbers; a long press will allow multiple assignment where as a short press will clear the previous settings.

Press the SET switch on the input channels to which the assignment is required. Again there are two ways to do this; a long press will remove all prior settings on the input and replace them with the new assignment; a short press will toggle the state of any switches within the assignment set up. i.e. if assign keys one and two are on. Pressing the input SET switch will cause that channel to toggle the number one and two assignments for the channel either from off to on or visa versa.

To enter CLEAR mode set all the assign keys to off.

To switch the assign keys off simply press the ones that are illuminated which will toggle them off.

In this mode operating an input SET switch with a long press will clear all the VCA and /or automute assignments. The mode switches can be used to select which parts are cleared, i.e. press VCA mode to clear VCA's, press MUTE mode to clear automutes, or use a long press to activate both VCA and MUTE mode for simultaneous clearing.

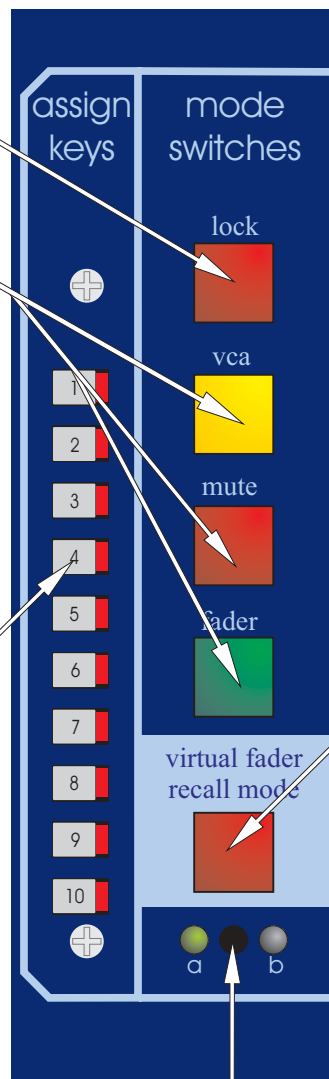

The VIRTUAL FADER switch enables the operation of the virtual fader system. The virtual fader system can only be active if the console is unlocked to RECALL, STORE or higher.

The A/B switch selects which micro card is controlling the console assignment and automation systems. This is a major function! At the point of change over there is no defined control of the faders within the fader tray and output levels will change. The A/B switch should there for be treated with the same cautions used at console power up/down.

For reliability the assignment and automation systems are 100% duplicated. The console can operate on either of the systems. All snap shots are stored on BOTH of the systems. The LED's indicate the status of each system in the following manner:-

LED green indicates which system is active
 LED off indicates which system is inactive
 LED red indicates that a system is damaged or not responding and that a service engineer must be called as soon as possible.

Snapshot Automation System

Snapshots can be stored in the automation system as ACTs or SCENEs. There is no difference between an ACT or a SCENE apart from the numbering; scenes are just sub sets within acts.

The AUTO MUTE GROUP MASTER switches (1 to 10) activate the mute circuits on any, mute group assigned, input channels.

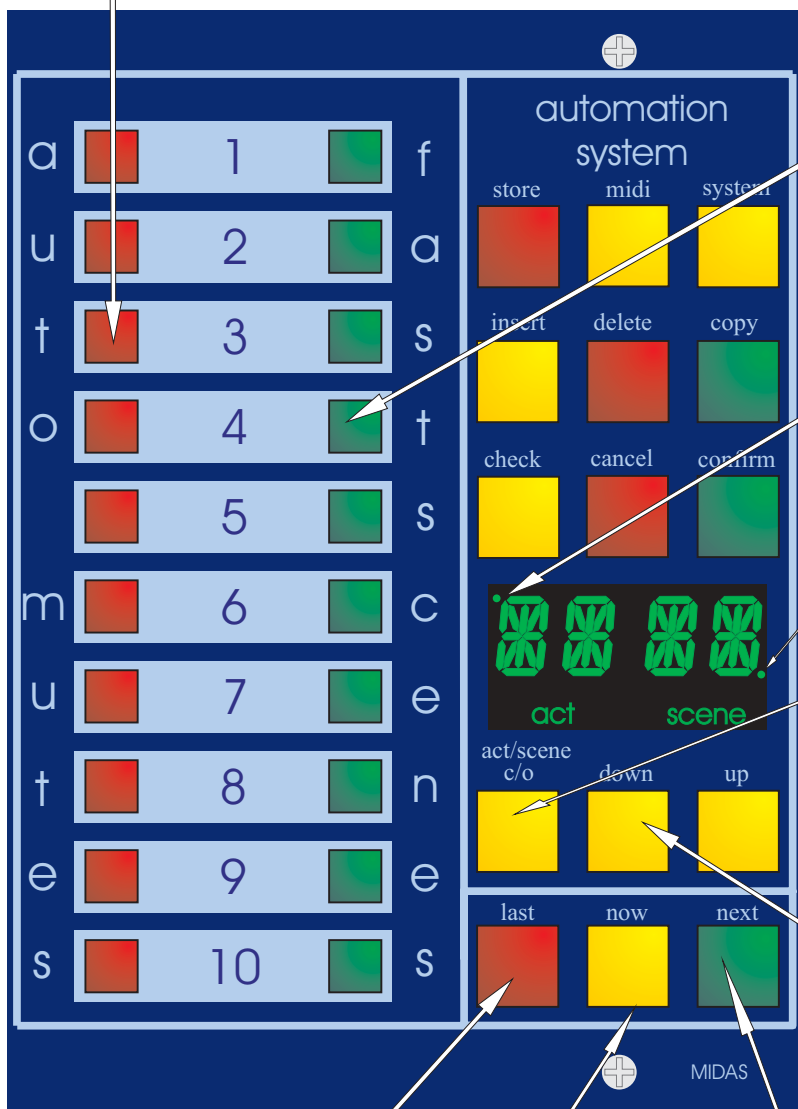

The FAST SCENE keys provide the operator with ten quick entry points within the ACT/SCENE sequence. i.e. If FAST SCENE key one is associated with ACT.SCENE 10.02, pressing it will recall ACT.SCENE 10.02. Fast scenes are generated by using the COPY switch as described on the next page.

If dot is lit the scene number displayed is the scene currently recalled.

If dot is lit the scene number displayed has scene information stored in it.

The ACT/SCENE C/O switch is used to select the acts or scenes in conjunction with the UP/DOWN switches. An appropriate indication, "ACT" or "SCENE", will be illuminated to indicate this status.

The UP/DOWN switches allow the operator to scroll through act/scene numbers and navigate through menus.

LAST recalls the snap shot numerically preceding the snap shot that is currently recalled/stored.

NOW recalls the snap shot that is currently indicated on the numeric display.

The LAST, NOW and NEXT switches recall snapshots to the console surface.

NEXT recalls the snapshot numerically preceding the snapshot that is currently recalled/stored.

The SYSTEM switch gives the operator access to the system menu. Navigation of the menu is achieved by using the UP/DOWN switches to select an entry and then pressing CONFIRM to execute the selected function or sub menu. To exit a menu or sub menu press CANCEL.

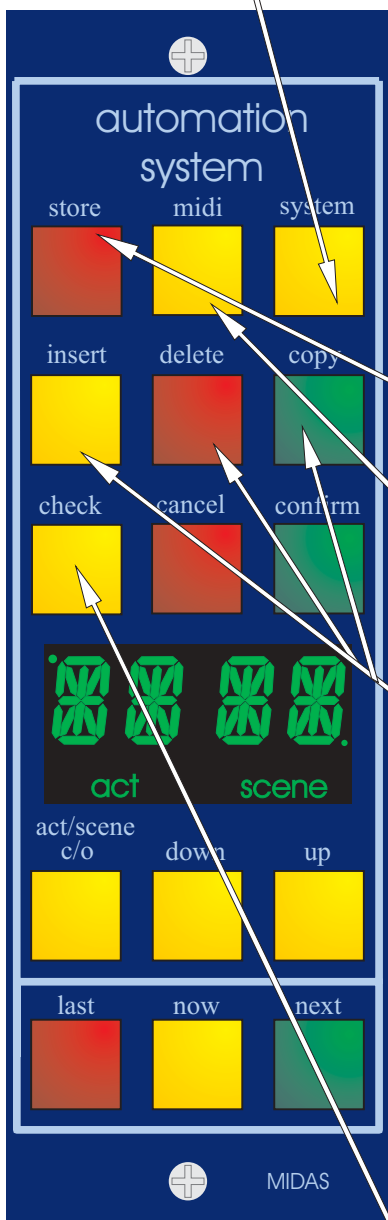

The system menu contains LOCK which defines the level of console operation.

These levels are: -

- TOTL All automation and assignment functions are disabled
- RCAL Only recall and assignment functions are available.
- STOR Scene storage/editing, recall and assignment are operational
- SYST All functions are available.

Operating the STORE key will store the current console assignments and settings to the snap shot being displayed on the numeric display.

The MIDI key allows the operator to edit the snap shot MIDI information. On entering this mode the operator will be presented with a menu of the four MIDI messages that are stored within each snap shot, its operation is similar to the system menu.

The COPY, DELETE and INSERT keys allow the operator to edit the snapshot sequence in the following manner.

INSERT. Pressing this key will allow the operator to insert a snapshot at the number on the numeric display. The scene that was originally at the number and all con-current scenes will be re-numbered by adding one to their scene numbers.

COPY. This will copy the snapshot currently displayed on the numeric display to a temporary memory location. This can then be stored or inserted to a new scene number in the normal fashion. When in copy mode a fast scene number can also be assigned to the scene by simply pressing the desired fast scene switch.

DELETE will erase the snapshot that is currently being displayed on the numeric display from the automation memory.

The CHECK switch provides a preview of any snapshot on the console surface WITHOUT recalling the ACTUAL setting to the console surface (mutes are displayed on the safe switches so that current mute status is always present and accurate). Whist in check mode the ACT/ SCENE C/O, and UP/DOWN switches can be used to step through the snapshots.

Fader Automation System

The fader automation operates in two main ways:-

REAL FADER MODE and VIRTUAL FADER MODE.

In REAL FADER MODE all of the internal VCA systems are controlled by the real (physical) faders. The automation system can assist in the control of the real faders by prompting the operator using the 11 LED's next to each fader.

If the console is un-locked to RECALL level or higher the operator can view the fader positions required for a given snapshot by recalling the scene and pressing the FADER MODE switch. The LED's will flash to display the approximate position that the fader should be set to and they will extinguish when the fader has been moved to the correct position. When the faders are close to the correct position the LED's will change to give "up" "down" indication either side of the required fader positions.

If the console is un-locked to STORE level or higher operator can recall scenes as above and can also store and overstore. When a store is made the fader position stored will always be the actual current position of the real fader.

In VIRTUAL FADER MODE the console automation takes control of all internal VCA systems and displays a representation of the virtual fader position using the 11 LED's next to each fader. Additional adjustment trims can be added if required using the real faders. The virtual fader system works in distinctly different ways depending on the lock status:-

If the console is un-locked to RECALL level or higher scenes can be recalled but not stored or overstored. If fader adjustments are required they are started by fader "pick up" at the "0dB position". Fader adjustments then remain active for all subsequent scenes recalled (unless the adjustment is "cleared").

If the console is un-locked to STORE level or higher scenes can be stored, recalled and overstored. When a store is made the fader position stored will always be the virtual fader position regardless of the real fader. If fader adjustments are required they are started by fader "pick up" at the current virtual fader position. As soon as a new scene is recalled by the automation the fader adjustment is removed forcing the operator to "pick up" again before making further adjustments.

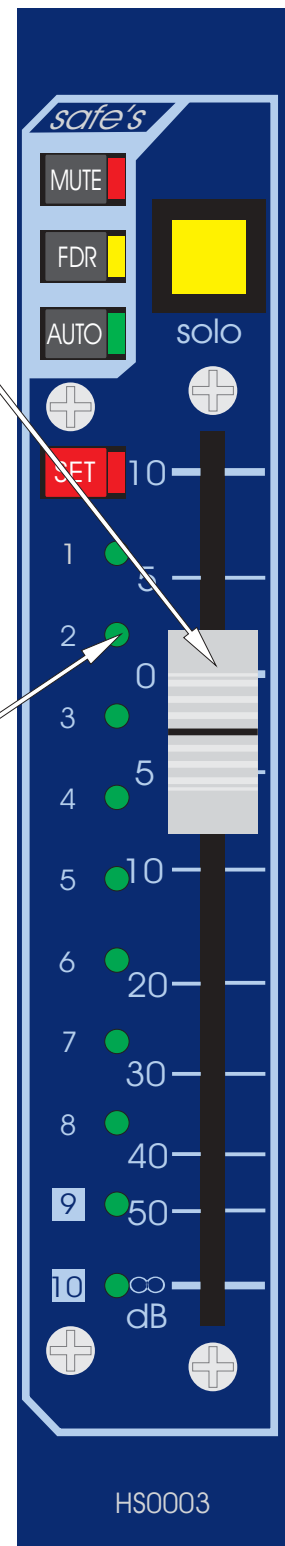

The differences between virtual fader recall and store are explained in more detail in the chart below:-

Recall Mode	Store Mode
<p>Recall a new scene and leds will indicate the current virtual fader positions. Note that that these leds <u>always</u> indicate the actual fader setting that is controlling the audio.</p>	<p>Recall a new scene and leds will indicate the current virtual fader positions. Note that that these leds <u>always</u> indicate the actual fader setting that is controlling the audio.</p>
<p>To adjust a virtual fader move the real fader to 0dB. When the fader is at 0dB the red set led will illuminate indicating that the virtual fader is ready for adjustment. Moving the fader will add an offset to the original stored scene. The amount of offset is clearly indicated by the physical position of the fader above or below the 0dB line. The virtual fader position can also be viewed via the leds (plus any adjustment offsets).</p>	<p>To adjust a virtual fader move the real fader to the same position as the virtual fader. When the fader has reached this point the red set led will illuminate indicating that the virtual fader is now “tracking” the real fader. Moving the real fader will there for adjust the position of the virtual fader and this is indicated by changes in the virtual fader leds.</p>
<p>If a new scene is recalled the fader adjustments made will be added to the new scene also. The adjustment can be removed by returning the fader to the 0dB position or by “clearing” the fader to -infin as detailed below.</p>	<p>If a new scene is recalled the fader adjustments will all be cleared and the set leds will extinguish to indicate that faders are not “tracking” even if their position suggests that they are (because they are not set to -infin).</p>
<p>In order to make the virtual fader leds as clear to view as possible it might be desirable to “clear” all non adjusted faders to -infin. To do this press the virtual fader switch and then move any fader that is to be “cleared” to the -infin position. Press the virtual fader switch again and the faders will be ready to be active again. Only faders which do not need adjustment should be cleared as any virtual fader level changes made prior to clearing will be removed at the next scene recall.</p>	<p>In order to make the virtual fader leds as clear to view as possible it might be desirable to “clear” all non adjusted faders to -infin. To do this press the virtual fader switch and then move any fader that is to be “cleared” to the -infin position. Press the virtual fader switch again and the faders will be ready to be active again. Any virtual fader level changes made prior to clearing will still be active but they will be cleared at the next scene recall.</p>

<p>It is possible to “pick up” all the faders and then set them to 0dB if adjustment is not required. There is no <u>need</u> to “clear” them. This is a user preference.</p>	<p>If faders are not cleared prior to recalling a new scene it may be advisable to clear them immediately afterwards to avoid confusion.</p>
<p>Any virtual fader can be isolated from further scene recall by pressing the AUTOMation SAFE switch. After the switch is pressed it will also be possible to “pick up” the virtual fader at the recalled position and adjust it using the real fader (exactly the same as for store mode). Any subsequent scene recall will have no effect on the virtual fader position.</p>	<p>Any virtual fader can be isolated from further scene recall by pressing the AUTOMation SAFE switch. After the switch is pressed it will also be possible to “pick up” the virtual fader at the recalled position and adjust it using the real fader. Any subsequent scene recall will have no effect on the virtual fader position.</p>
<p>To regain virtual fader control switch the AUTOMation SAFE switch off and then recall the current (or next required) scene. Virtual fader control will resume as the scene is recalled. The fader will not be “picked up” and can be moved to -infin if desired as long as it does not pass through 0dB. If it does pass through 0dB it will “pick up” in the normal way.</p>	<p>To regain virtual fader control switch the AUTOMation SAFE switch off and then recall the current (or next required) scene. Virtual fader control will resume as the scene is recalled. The fader will not be “picked up” and can be moved to -infin if desired as long as it does not pass through the virtual fader position. If it does it will “pick up” in the normal way.</p>
<p>Any input channel virtual fader can be <u>totally</u> isolated by pressing the FADER SAFE switch. At this point the virtual fader will "snap" to match the real fader position and any master VCA and automation control will be removed. To regain virtual fader control switch the fader safe off and recall a new scene. The real fader can then be cleared to -infin in the normal way.</p>	<p>Any input channel virtual fader can be <u>totally</u> isolated by pressing the FADER SAFE switch. At this point the virtual fader will "snap" to match the real fader position and any master VCA and automation control will be removed. To regain virtual fader control switch the fader safe off and recall a new scene. The real fader can then be cleared to -infin in the normal way.</p>
<p>It is not possible to store a scene in this mode. The main reason this is not allowed is because multiple overstores of faders which have adjustments made would result in incremental virtual fader position changes which in most cases would not be desired.</p>	<p>When storing a scene the information loaded into the scene memory will always be as displayed by the leds. This still applies if a fader is isolated by the fader safe or automation safe switches.</p>

As you can see from the previous two pages there are many different ways to control faders within the console. There is no right or wrong way and the best method will depend largely on the specific application and the user preference. It is quite likely that the method chosen will change with time as the user gains more confidence in the system the performance becomes more regular and rehearsed. The following recommendations are intended as a guide only:-

1. REAL FADER STORE AND RECALL MODES

Used for initial set up of a show and during early rehearsals. Also used for situations where no prior setup has been possible. Fader positions stored to the automation memory are as per the real faders so great care must be taken to set them correctly prior to over storing any adjustments.

2. VIRTUAL FADER STORE MODE

Used for later rehearsals and for shows where there is a large degree of change from night to night due to venue conditions or add lib's etc. Each scene recalled is as it was stored but may need adjustment to suit the prevailing conditions. Adjustments are clear and fast to implement with the real fader taking over from the virtual fader as required. Over storing is easily possible so as to fine tune the data stored in the automation memory.

3. VIRTUAL FADER RECALL MODE

Used for events and shows that are well rehearsed and predictable. Each scene recalled is as it was stored plus an offset adjustment from the real fader if required. Any adjustments that are made are active for all subsequent scenes until such time as they are removed by the operator. Over storing is not possible.

Heritage Menu Overview Ver 2.06

(Key  this symbol denotes a CONFIRM button press)

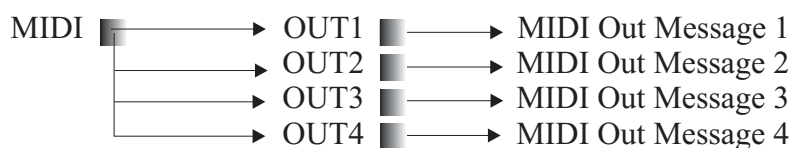
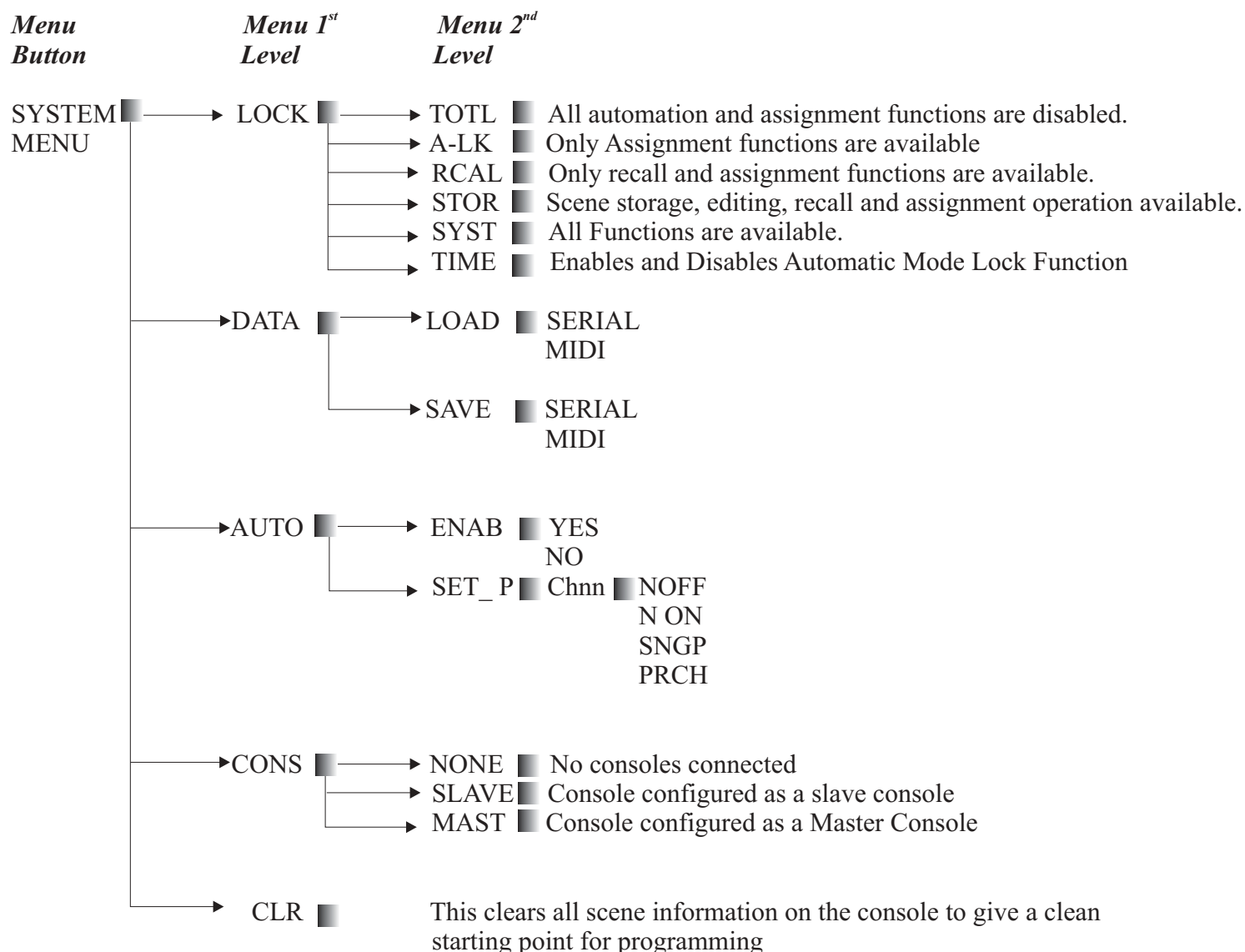

MIDI Out Sub Menus:
(Ø denotes a number)

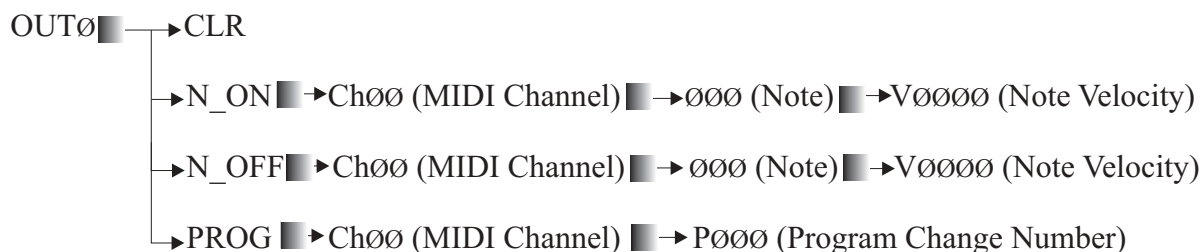

Store Menu If storing new scene

When storing a new scene there are no options available, the scene will be stored with the fastest cross fade speed and the display will revert back to default.

Store Menu When Overstoring

When Overstoring an existing scene the following options are available.

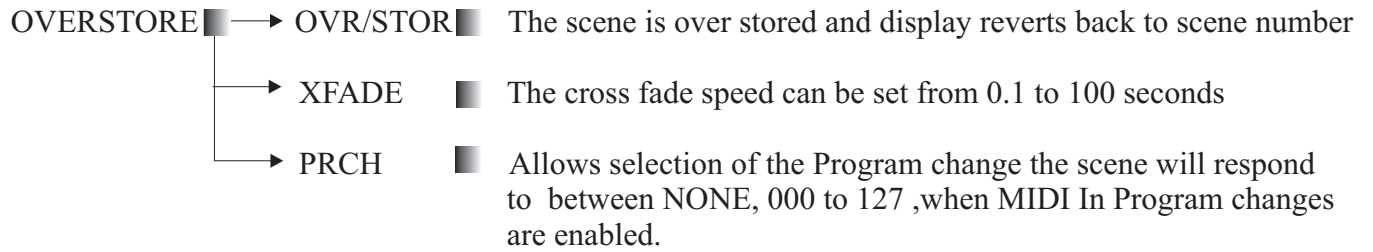

Unlocking the Console:

To unlock the mixing console press the SYSTEM menu button. Using the up/down keys scroll through the menu until LOCK is displayed, press CONFIRM. Using the up/down keys scroll through the menu until the desired level of unlock is displayed on the screen, then press the confirm button.

Locking the Console:

To lock the mixing console press the SYSTEM menu button. Using the up/down keys scroll through the menu until LOCK is displayed, press CONFIRM. Using the up/down keys scroll through the menu until TOTL is displayed on the screen, then press the CONFIRM button.

The LOCK button located on the MODE SWITCHES disables the Assign keys, Mode switches and Set switches on the Centre section and input faders.

Storing a Scene:

Setting up a scene, Assigning VCA, Mutes, Faders etc.

Assigning VCA's:

- a/ Ensure that the lock button is not illuminated on the mode switches (if it is just press the button to extinguish the LED).
- b/ Press the VCA mode button so that it is illuminated. This has now selected the VCA mode on the input modules.
- c/ Using the ASSIGN KEY select which master VCA you wish to assign to a particular input module (1-10). Quickly enabling a button will clear all other buttons enabled so only the one selected is illuminated, push and holding the button down for 0.25seconds will not disable other buttons previously enabled.
- d/ On the input channels you wish to assign to the master VCA(s) selected press the SET Button, the relevant LED(s) on the input channel will illuminate. If the SET button is pressed quickly the VCA's selected on the assign keys will be added to those already selected on the channel. If the SET button is pressed and held for a short time then any VCA's already selected on that channel will be cleared and replaced with those selected on the assign key.

Assigning Mutes:

- a/ Ensure that the lock button is not illuminated on the mode switches if it is just press the button to extinguish the LED.
- b/ Press the MUTE mode button so that it is illuminated. This has now selected the mute mode on the input modules.
- c/ Using the ASSIGN KEY select which Automutes you wish to assign to a particular input module (1-10). Quickly enabling a button will clear all other buttons enabled so only the one selected is illuminated, push and holding the button down for 0.25seconds will not disable other buttons previously enabled.
- d/ On the input channels you wish to assign to the Automutes selected press the SET Button, the relevant LED(s) on the input channel will illuminate. If the SET button is pressed quickly the Automutes selected on the assign keys will be added to those already selected on the channel. If the SET button is pressed and held for a short time then any Automutes already selected on that channel will be cleared and replaced with those selected on the assign key.

Fader Position:

- a/ Ensure the Virtual Fader recall mode button is not illuminated and the faders are in normal mode, if this is enabled the new fader position will not be stored.
 - b/ Move the faders to the desired position.
- The only other automated buttons on the console to be set are the Input Mutes, Master VCA Mutes, Group Mutes, Matrix Mutes and Master Mutes.

Storing a Scene Cont.

Selecting a memory number and storing the memory:

- a/ The numbers in the display can be altered as follows. Select either Act or Scene using the ACT/SCENE C/O switch. You will see either act or scene illuminate below the display.
- b/ The digits can then be altered between 00-99 using the UP and DOWN keys. This function is looping so if you are on 00 you can go directly to 99 by scrolling down.
- c/ To store a scene press STORE in the scene is new then it will just be stored and the screen will display done. If the scene already exists then the display will read over_str and you will need to press the confirm button. The screen will then read done.

Editing Midi (Program Change):

- a/ Pressing the MIDI button places you in the MIDI menu.
- b/ Using the UP and DOWN buttons scroll through OUT01 to 04 until the required message is reached. (On the Heritage there are a maximum of 4 MIDI out messages that can be sent per recalled scene). Press CONFIRM.
- c/ Using the UP and DOWN buttons scroll through the menu until the screen reads PROG. Press the CONFIRM button
- d/ The window will read CH00, using the UP and DOWN keys a channel between 01 to 16 can be selected. Press CONFIRM.
- e/ The window P000, using the UP and DOWN keys a program, change between 00 and 127 can be selected. Press confirm and you will be dropped back to the first level of the menu. When the desired messages have been edited press the MIDI button again to drop out of the menu.
- f/ To then store the MIDI information with the scene the STORE button must be pressed followed by CONFIRM

Assignment of Program changes to a Scene:

- a/ Once a scene has been stored press the STORE button so that the display reads OVER/STOR.
- b/ Press the UP key until the display reads PRCH then press CONFIRM.
- c/ Using the UP or DOWN key chose the required MIDI program change you wish the scene to be recalled by. You have the choices NONE, Program Changes 000-127.

Inserting Scenes:

- a/ Once you have created the scene you wish to insert edit the act/scene number display using the ACT/SCENE, UP and DOWN buttons until the desired position is displayed.
- b/ Press the INSERT switch. The screen will then display *done*. The original scene and any scene preceding it will then be incremented by one position.

NB The INSERT button will only be illuminated if a scene exists where you wish to place the scene, otherwise STORE may be used as normal.

Copying Scenes:

- a/ Recall the scene you wish to copy by selecting the scene number and pressing the NOW button.
- b/ Press the COPY button.
- c/ The MIDI Button will be illuminated as default which indicates that the midi out messages will also be copied with the scene. If you do not wish the midi out information to be copied to the new scene press the MIDI button so that the light is extinguished.
- d/ The act/scene numbers can now be scrolled through using the ACT/SCENE,UP and DOWN buttons until the desired position is reached, then press the STORE button.

Editing the Cross fade Value of a Scene:

- a/ Recall the scene you wish to copy by selecting the scene number and pressing the NOW button.
- b/ Press the STORE button, and using the UP and DOWN buttons scroll through the display until XFADE is shown, press CONFIRM.
- c/ The current cross fade speed stored with the screen will be displayed. Using the UP and DOWN buttons select the required cross fade speed.
- d/ Press CONFIRM to store this new speed with the scene.

NB When a scene with a cross fade speed is being recalled the display will flash for the specified cross fade time

Halting a Cross fade:

To Pause a crossfade during recall press the CANCEL button. The crossfade can be resumed again by pressing the CONFIRM button.

Bypassing a Cross fade:

A crossfade can be bypassed by pressing the confirm button as the crossfade is being applied, this will immediately take you to the finished scene.

Previewing a Scene:

To preview a scene without effecting your mix select the scene number on the display using the ACT/SCENE, UP and DOWN buttons. Once the desired number is displayed using the CHECK button the automated switch configuration and fader positions stored for that scene can be viewed without changing the actual settings.

The Automute Safe buttons on the inputs will display the input mute state.

The master VCA mutes will display the Master VCA mute setting with out altering the Audio.

The Group and Matrix Mute Safe buttons will display the checked scene mute status.

The display will also scroll through the other stored scene information, telling you if midi in is enabled and the channel assigned. The MIDI out information stored with the scene, cross fade value and program change number the scene will respond to.

Pressing the CHECK button will drop you back into normal mode.

Recalling Scenes:

There are 3 methods by which scenes can be recalled:

- a/ Stepping through existing scenes using the LAST and NEXT buttons. This steps through the scenes in numerical order.
- b/ Select the act/scene number using the ACT/SCENE, UP and DOWN buttons, when the correct scene number is displayed in the screen press the NOW button and the scene will be recalled.
- c/ A scene can be assigned to a fast scene key (1-10). In this instance the scene is recalled by just pushing the fast scene key.

Assigning A Scene To A Fast Scene Key:

- a/ Recall the scene you wish to assign to a FAST SCENE KEY.
- b/ Press the COPY button, followed by the FAST SCENE KEY button you wish to assign that ACT/SCENE to. The screen will then display *done*.

Deleting a Scene From A Fast Key:

- a/ Press and hold down the FAST KEY you want to delete.
- b/ When the YES and NO button start to flash you can now select either YES or NO to delete or cancel deletion of the FAST KEY.

Deleting A Scene:

Recall the scene you wish to delete, Or display the scene number on the screen using the ACT/SCENE, UP and DOWN buttons. When this is done press the DELETE button. You will be asked to confirm this. Press the CONFIRM button the screen will then say *done* when the scene is deleted.

Midi In Assignment:

Setting The Console to Respond to MIDI Changes:

The console settings can be accessed via the “AUTO” submenu after pressing the “System” button. This submenu option is only available when in “SYS” Lock-Mode.

After selecting “AUTO”, there are two further sub-menus:

1. ENAB -(ENABLE), this is the master switch for this function and can be set to “YES” or “NO”. Toggling this switch will not delete the other setup parameters for this function.
2. SETP - (SETuP), this is where we set the actual midi parameters that are used for this function. These parameters define the midi command that the console will respond to, and decode the required act/scene number. The two parameters that can be set are as follows:
 - a. The midi command, this can be either of the following midi commands:
 - N ON - (Note ON)
 - NOFF - (Note OFF)
 - SNGP - (Song Pointer)
 - PRCH - (Program Change)
 - b. The MIDI channel, this covers the full 16 channels possible, the display shows CH 01 - CH 16.

Notes:

1. To respond to an external midi request to change the act/scene number, the following conditions must be true:
 - a. The “AUTO - ENAB” menu setting must be set to “YES”.
 - b. The console must not be in “TOTL” (TOTaL) Lock-Mode.
 - c. The console use must not be performing any menu operations.

Setting Up a Midi Device:

To cause the console to automatically change its act/scene, a MIDI command can be sent using the pre - programmed command & channel (as set on the console). The actual act/scene number is encoded into the MIDI command data that is sent.

The required MIDI command data can be constructed by setting the midi command parameters as follows:

Note ON/OFF : These MIDI commands have two parameters, as follows:

1. NOTE, this parameter is equivalent to the required “ACT” number.
Each note has a numerical equivalent (see table below)
2. Velocity, this parameter is equivalent to the required “SCENE” number.

Example: To program a change to ACT 20, SCENE 44, - Set the note to G#-1, set velocity to 44.

Song Pointer - The command is a numerical value and is equivalent to the combined “ACT” & “SCENE” number.

Example: To programme a change to ACT 45, SCENE 02, - set the value to 4502

MIDI "NOTE" to numerical value lookup table

NOTE	OCTAVE										
	-1	0	1	2	3	4	5	6	7	8	9
c	0	12	24	36	48	60	72	84	96	108	120
c#	1	13	25	37	49	61	73	85	97	109	121
d	2	14	26	38	50	62	74	86	98	110	122
d#	3	15	27	39	51	63	75	87	99	111	123
e	4	16	28	40	52	64	76	88	00	112	124
f	5	17	29	41	53	65	77	89	01	113	125
f#	6	18	30	42	54	66	78	90	02	114	126
g	7	19	31	43	55	67	79	91	02	115	127
g#	8	20	32	44	56	68	80	92	03	116	-
a	9	21	33	45	57	69	81	93	04	117	-
a#	10	22	34	46	58	70	82	94	05	118	-
b	11	23	35	47	59	71	83	95	06	119	-

MIDI Sysex Dumps:

To store the recall a memory between the console and a midi device or the windows software available from Midas (such as an Yamaha MDF3 midi Filer) select the SYSTEM menu, using the UP and DOWN keys select DATA and press CONFIRM. Using the UP and DOWN keys select either SAVE or LOAD and press CONFIRM. There are 2 of communication either MIDI (through the midi port rear of the console or via RS232 (NB software will shortly be available to support this). Select either MIDI or SERIAL using the UP and DOWN buttons and press CONFIRM. The screen will then indicate the function being carried out and notify the user when finished.

Saving The Memory From The H3000 To A File

- 1/ Connect the null modem cable.
- 2/ Select the Show menu and click on 'Download From Console'. A window will open and set up the Comm port. The message Waiting for Show data will then be displayed.
- 3/ Select the 'SYSTEM' menu on the H3000 and scroll to 'DATA'. Press 'CONFIRM', then scroll to 'SAVE' and press 'CONFIRM'. Now scroll to 'RS-232' and press 'CONFIRM'. The show memory from the H3000 will then be down loaded into the computer. When the data transfer is complete, the H3000 will ask you to confirm the STORE OK, press 'CONFIRM'.
- 4/ Select the Show menu in Hsutil and click on Save To File.
- 5/ A prompt will appear asking for a show a name. Give the file type as *.shw.
- 6/ Click on OK and the file will be saved.

Down Loading A Show Into The H3000

- 1/ Connect the null modem cable.
- 2/ Select Show menu and click on 'Load From File'. Using the browse function select the show you wish to download into the console and click on OK. A window will open telling you the loading is complete, click on OK.
- 3/ Select the Show menu in Hsutil and click on Upload to console. A window will open asking you to hit upload when console is ready.
- 3/ Select the SYSTEM menu on the H3000, and scroll to 'DATA' then press 'CONFIRM'. Scroll to 'LOAD' and press 'CONFIRM'. Now scroll to RS232 and press 'CONFIRM'.
- 4/ Click on the 'Upload' button.
- 5/ When the file is downloaded successfully, the H3000 will prompt you to press 'CONFIRM'. The show memory from the computer will now be loaded into the H3000.

Linking Heritage Consoles together Via CAN:

A maximum of 6 consoles can be linked via the CAN bus connector located at the rear of the Heritage consoles. Any mixture of any Heritage consoles may be linked H3000,H2000 or H1000..

They are linked using a cable the description of which is given on the next page. If you have more than 2 consoles in a system the end consoles(either end of the cable) must have the RED termination button in the out position (default), all other consoles must have this Red button pressed in.

When linked only one console can be the master at any one time, all other linked consoles are slaves. The following functions are linked:

- Master VCA Control
- Master AutoMute Control
- VCA Master Solo
- Solo in Place Mode
- Scene Storage and Recall (See attached Note 1)
- Mode Switches
- Automation Assignment Keys
- Solo On
- Solo Clear (See Note 2)

Note 1

All scene memory information remains local to the console so when saving or loading memories to or from the console by either computer file or midi sysex dump, each console must be done individually.

When setting up a multiple console system it is recommended that programming is done from the start with all consoles linked. This is to avoid recalling a scene that does not exist on a slave console. If this is done you will see a warning message on the Master indicating that the scene does not exist and prompting for conformation at which point the master will recall the required scene but the slave will remain on the last existing scene recalled.

Midi may only be stored locally on a console, if you wish to program midi outs on slave console you must first make this the master or stand alone (this will be described later) and then program your midi out messages as normal.

Note 2

As the Solo add and Clear function of the Heritage 1000 are controlled differently to that of the 3000 and 2000. The solo CLR and ADD functions are not linked and must be triggered locally on any 1000 linked into a system.

Switching a Console to Master or Slave:

- a/ Press the SYSTEM menu and using the UP and DOWN keys scroll to CONS then press CONFIRM.
- b/ Using the UP and DOWN keys select either Master or Slave then Press CONFIRM.
- c/ You will then be prompted to choose the ID number of the console using the UP and DOWN keys you have a choice of ID 1 to 8, No 2 consoles in the same system must have the same ID.
- d/ Pressing CONFIRM will then synchronize the console with the system.

Note When a console is in slave mode CONS is the only item of the SYSTEM menu that can be accessed. If a slave console is reconfigured to be a master it will automatically make the original master console a slave when the CONFIRM button is pressed.

Cable Specification		CAN CABLE HS-CAN-8-01	Page 1 of 1.
		H1000 / H2000 / H3000	ACBLX-1606-1

Item	Description	Qty	Manufacturers' Reference	KT Part No.
Connectors				
1.	5 Pin XLR NC5MXB X-Series	2	Neutrik: NC5MXB	CON31-5MXB
2.	5 Pin XLR NC5FXB X-Series	1	Neutrik: NC5FXB	CON31-5FXB
Cable				
3.	Cardinal 48400 'Starquad' 4 Core Cable	8m	Farnell: 152-133	

Connector Pins	Signal	Cable Core	Cable Colour
Pin 1	NA	No Connection	NA
PIN2	CAN_L	CABLE CORE 1	BLUE
PIN3	0V CAN	CABLE CORE 3	GREEN
PIN4	CAN_H	CABLE CORE 2	RED
Pin5	NA	No Connection	NA
CASE	CHASSIS	Braid Screen	TIN
No Connection	NA	Cable Core 4	White

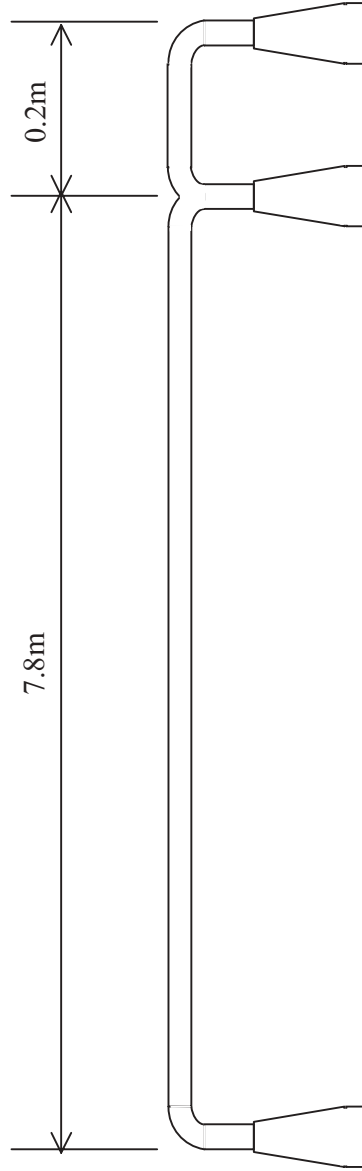

Issue	Date	Notes/ECN	Drawn:	Alison Ashmore	Drawing Number
1	01-12-99	Released to Production	Checked:		ASI606-1
2			Approved:		
3			From: N/A	To: N/A	
4			Connector (n/a)	Connector (n/a)	

HERITAGE 3000

Back panel

Cover Release
Catch Location

Cover Release
Catch Location

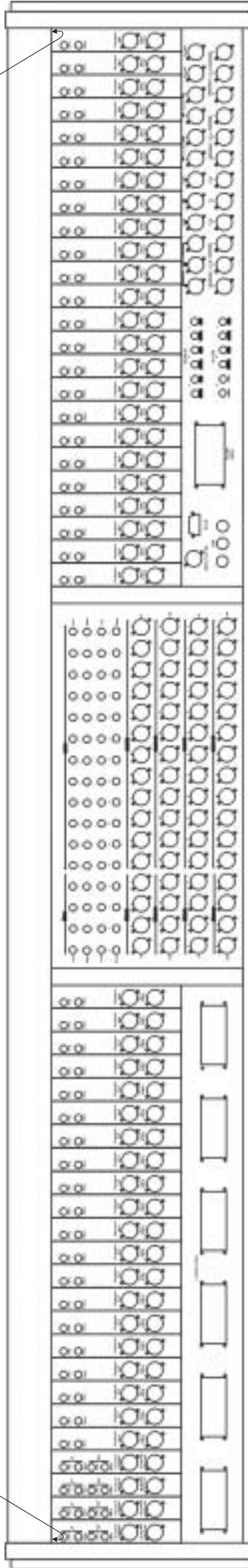

Rear Panel Left View

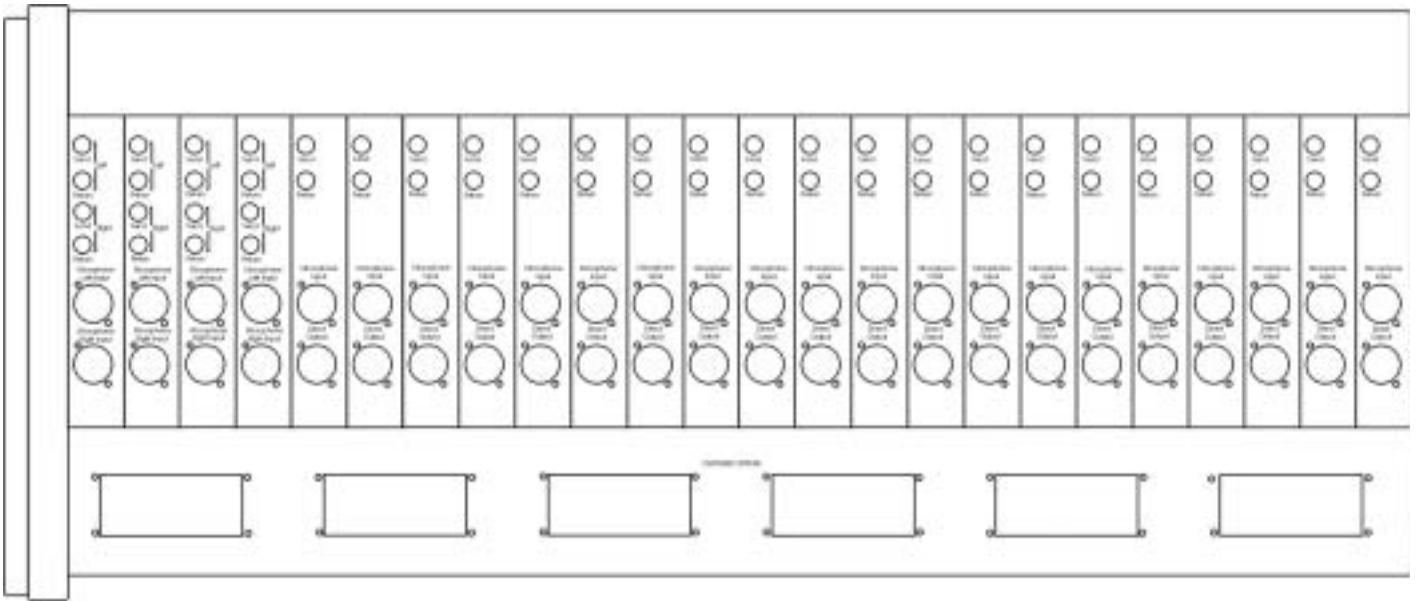

Rear Panel Centre View

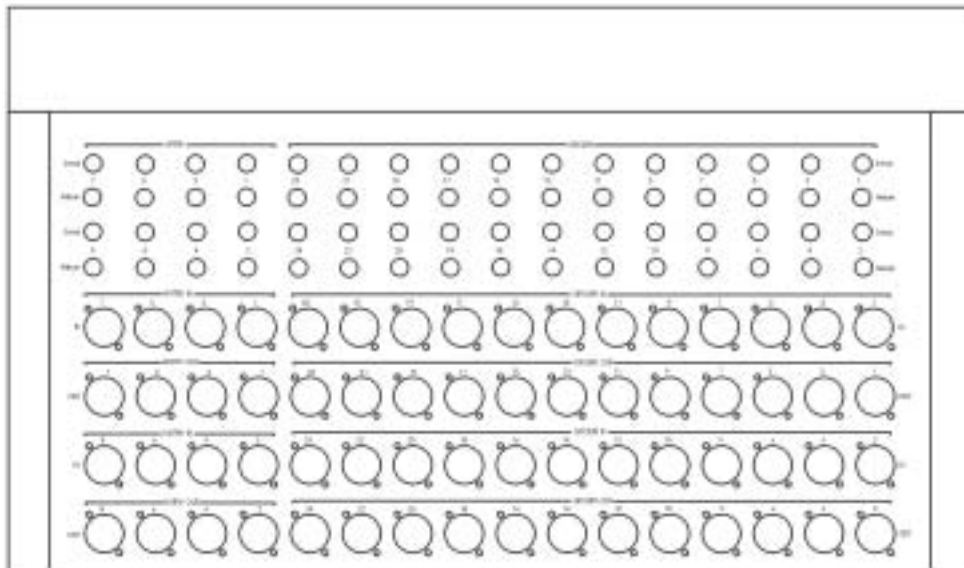

Rear Panel Right View

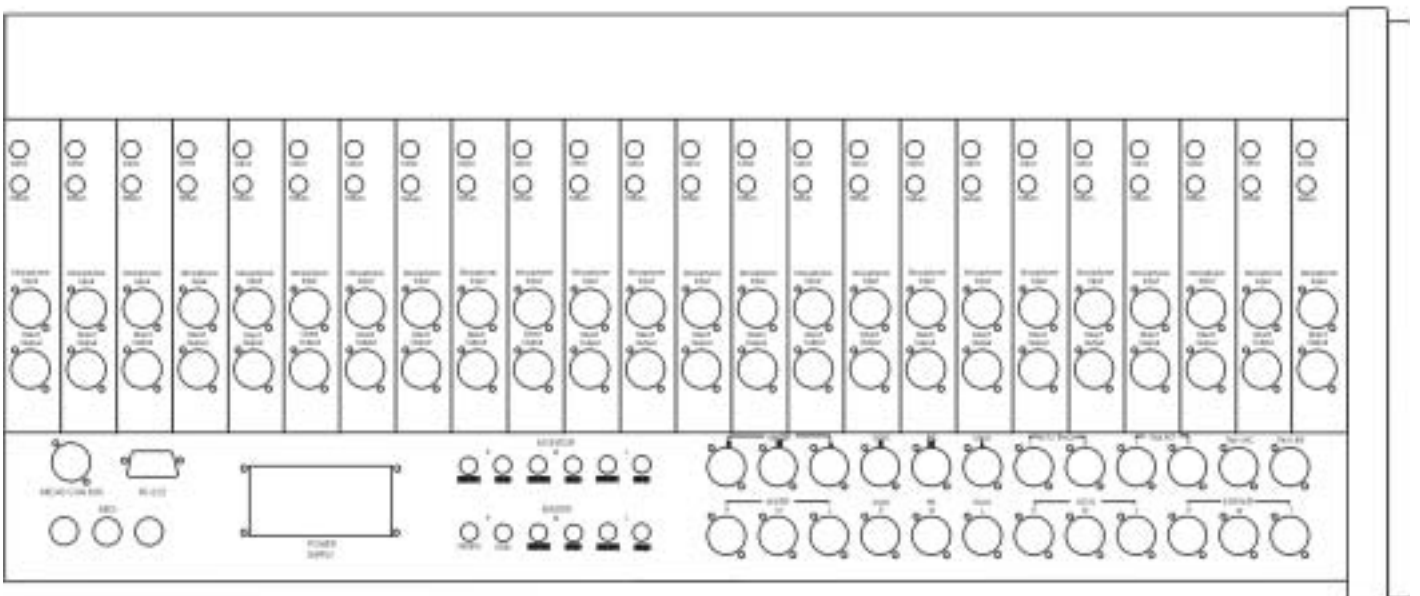

Heritage 3000 Frame Measurements

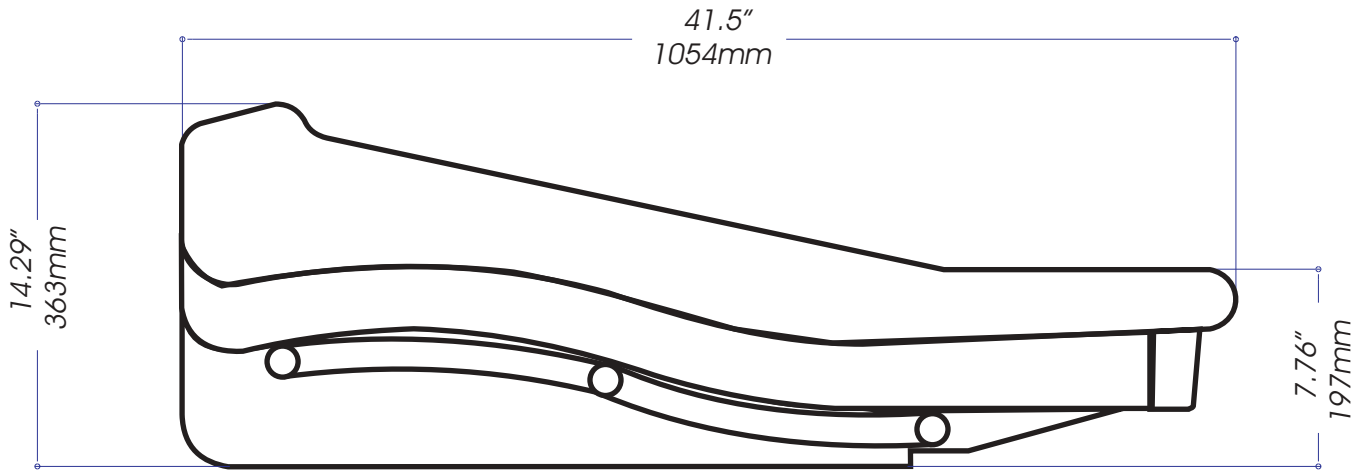

Configuration data

24 channel	20 mono/4 stereo	140kg 308.6lbs	1054mm x 1441mm	41.49" x 59.73"
32 channel	28 mono/4 stereo	165kg 363.8lbs	1054mm x 1713mm	41.49" x 67.44"
40 channel	36 mono/4 stereo	188kg 414.5lbs	1054mm x 1985mm	41.49" x 78.15"
48 channel	44 mono/4 stereo	215kg 473.9lbs	1054mm x 2257mm	41.49" x 88.86"
56 channel	52 mono/4 stereo	253kg 564.4lbs	1054mm x 2529mm	41.49" x 99.57"
64 channel	60 mono/4 stereo	260kg 573.2lbs	1054mm x 2772mm	41.49" x 109.1"
16 extender	user specified	80kg 176.4lbs	1054mm x 657mm	41.49" x 25.88"

These weights are approximate and taken out of flight case.
Also available as a bob-tail.

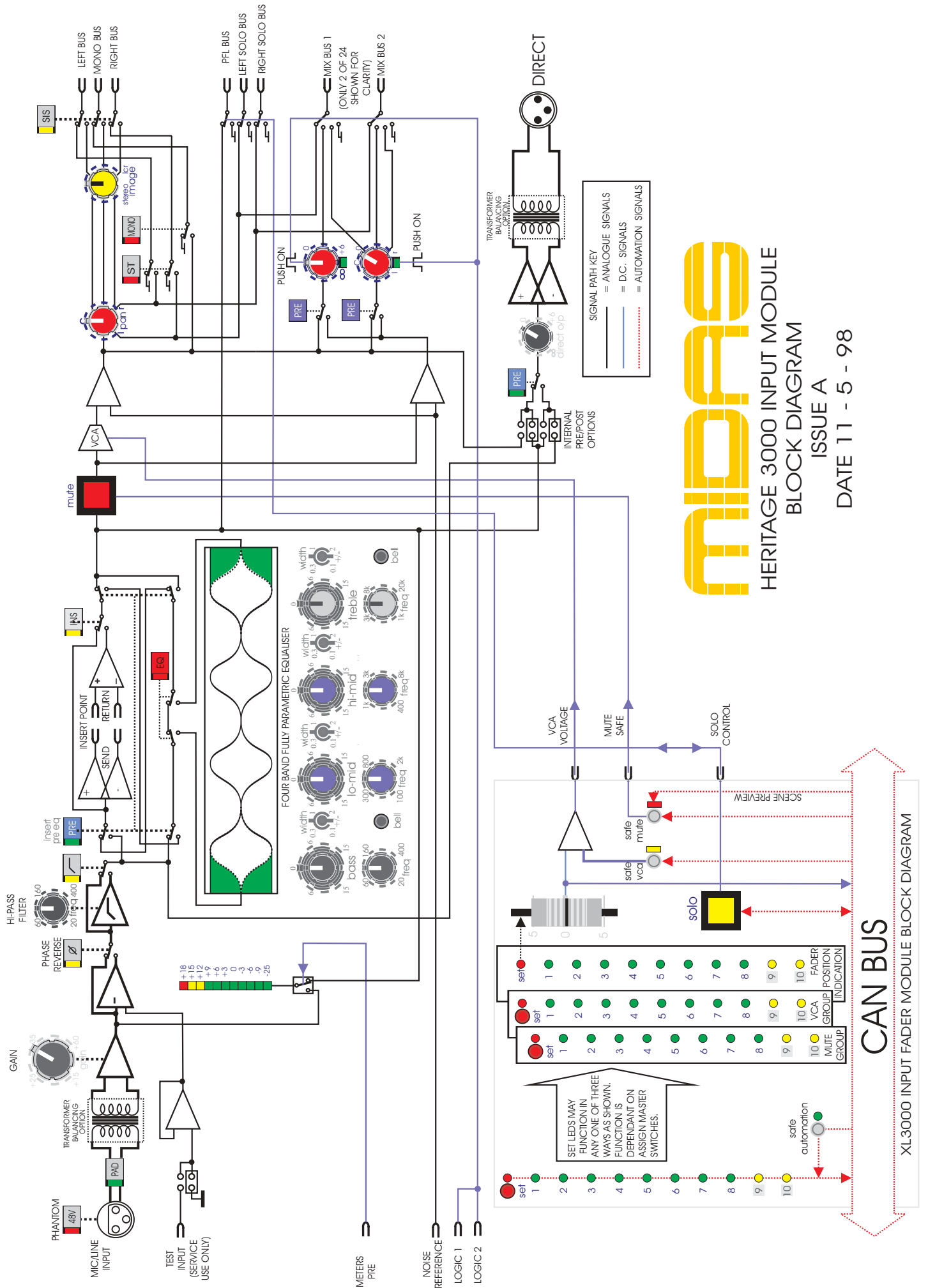

MIOPES

HERITAGE 3000 INPUT MODULE
 BLOCK DIAGRAM
 ISSUE A
 DATE 11 - 5 - 98



HERITAGE 3000 GROUP MODULE BLOCK DIAGRAM

ISSUE A

DATE 1 - 5 - 98

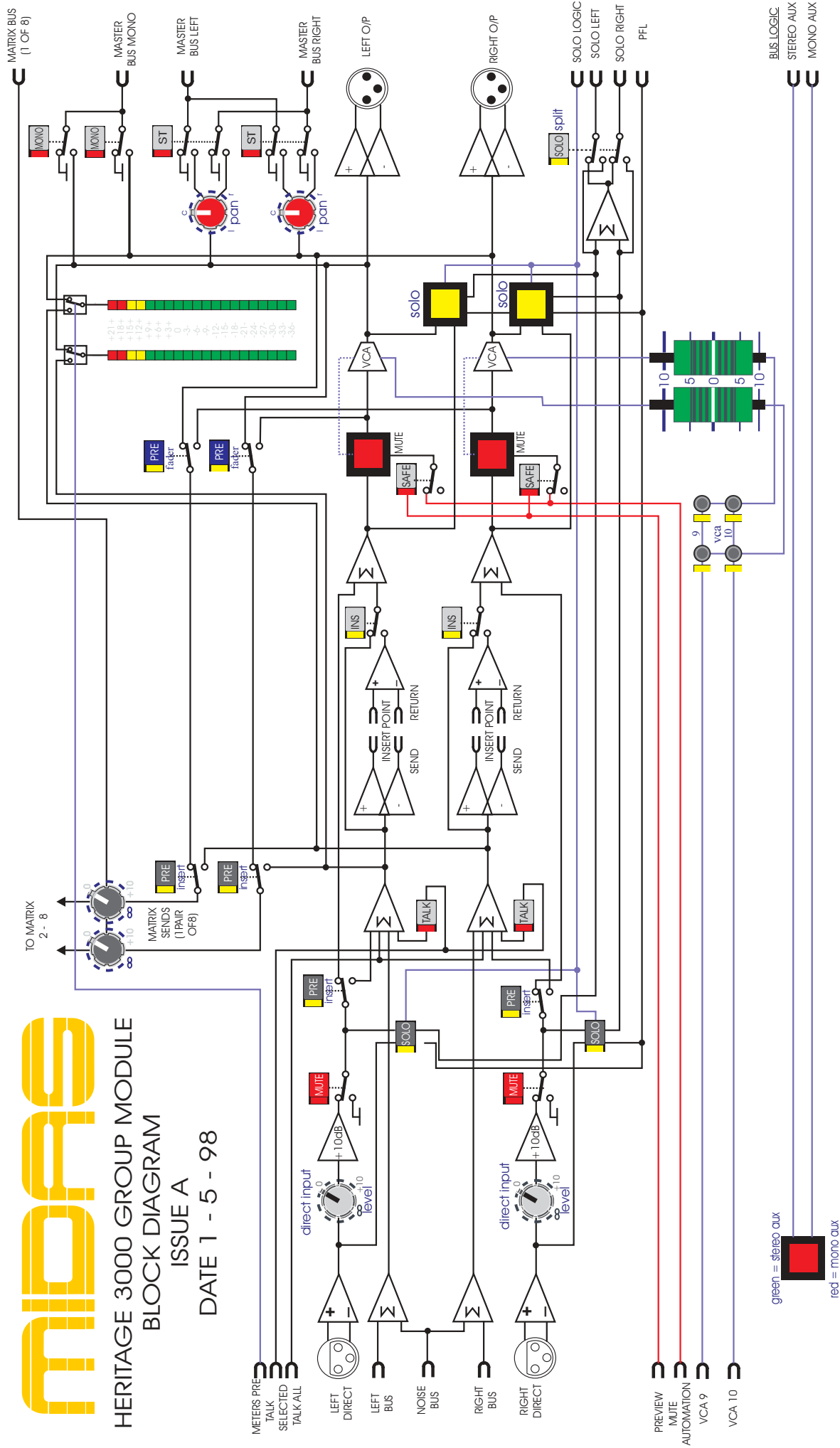



HERITAGE 3000 MATRIX MODULE
BLOCK DIAGRAM
ISSUE A
DATE 1 - 5 - 98

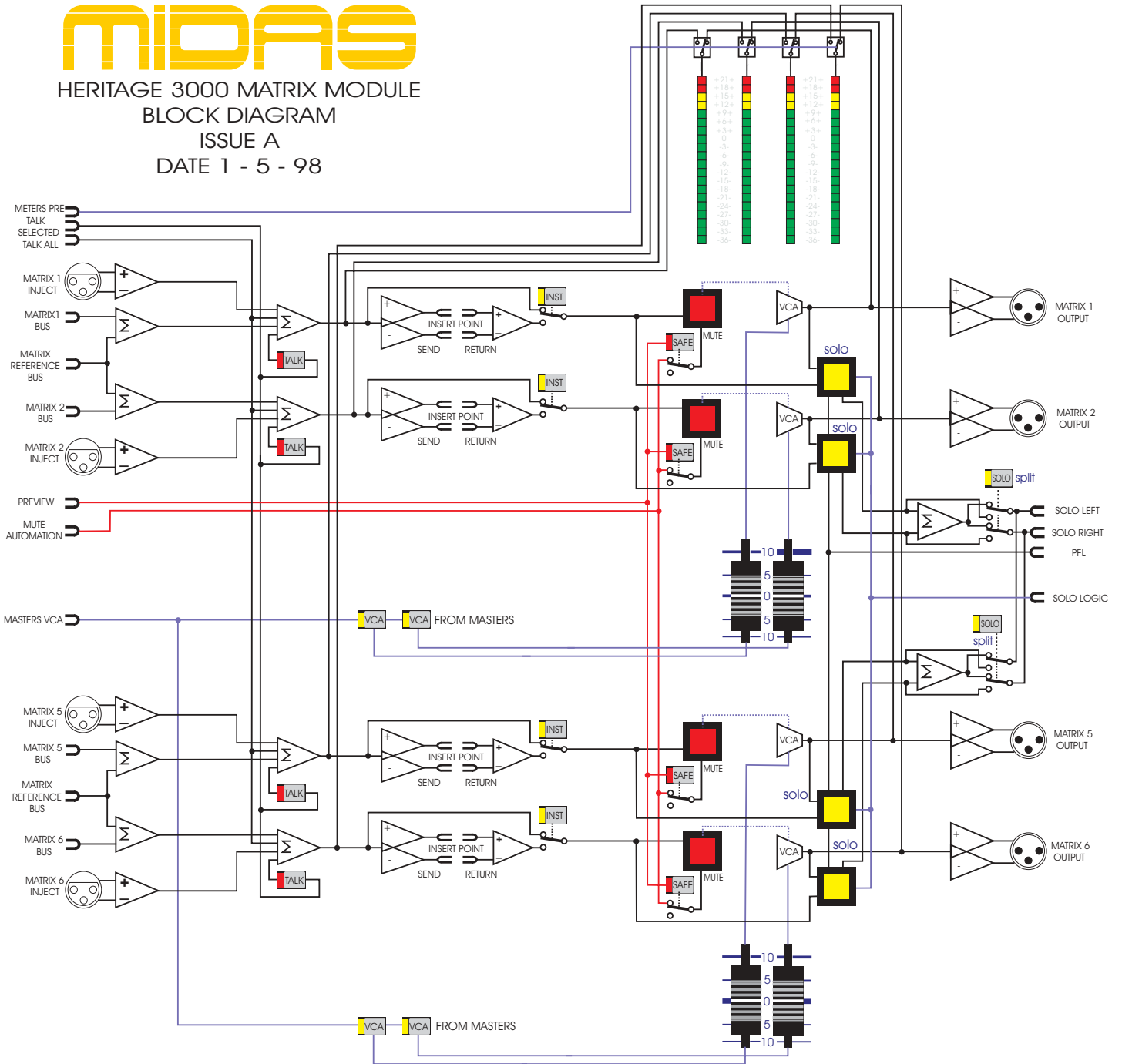



HERITAGE 3000 MASTER MODULE BLOCK DIAGRAM ISSUE A DATE 30 - 4 - 98

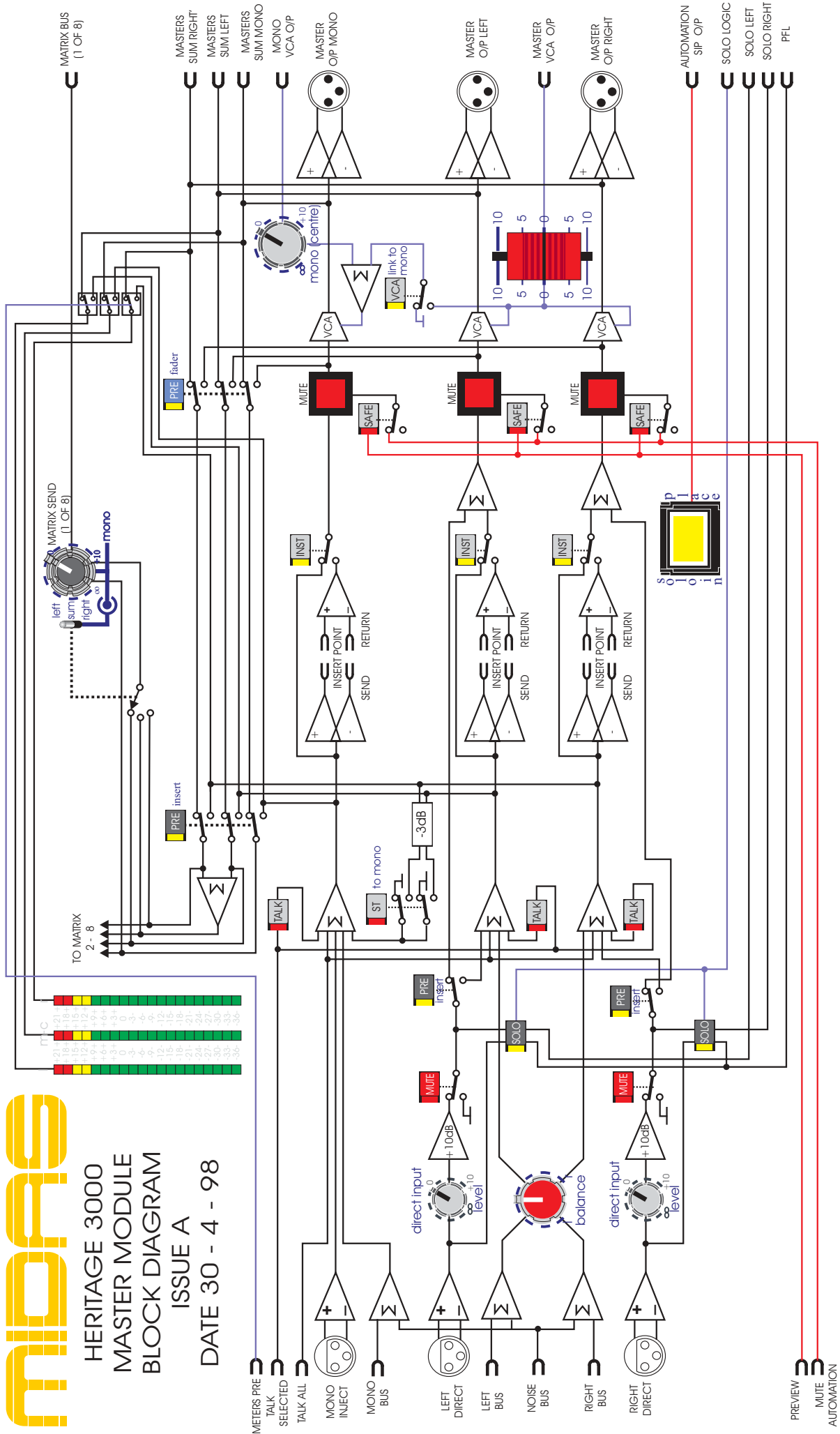

PREVIEW
MUTE
AUTOMATION

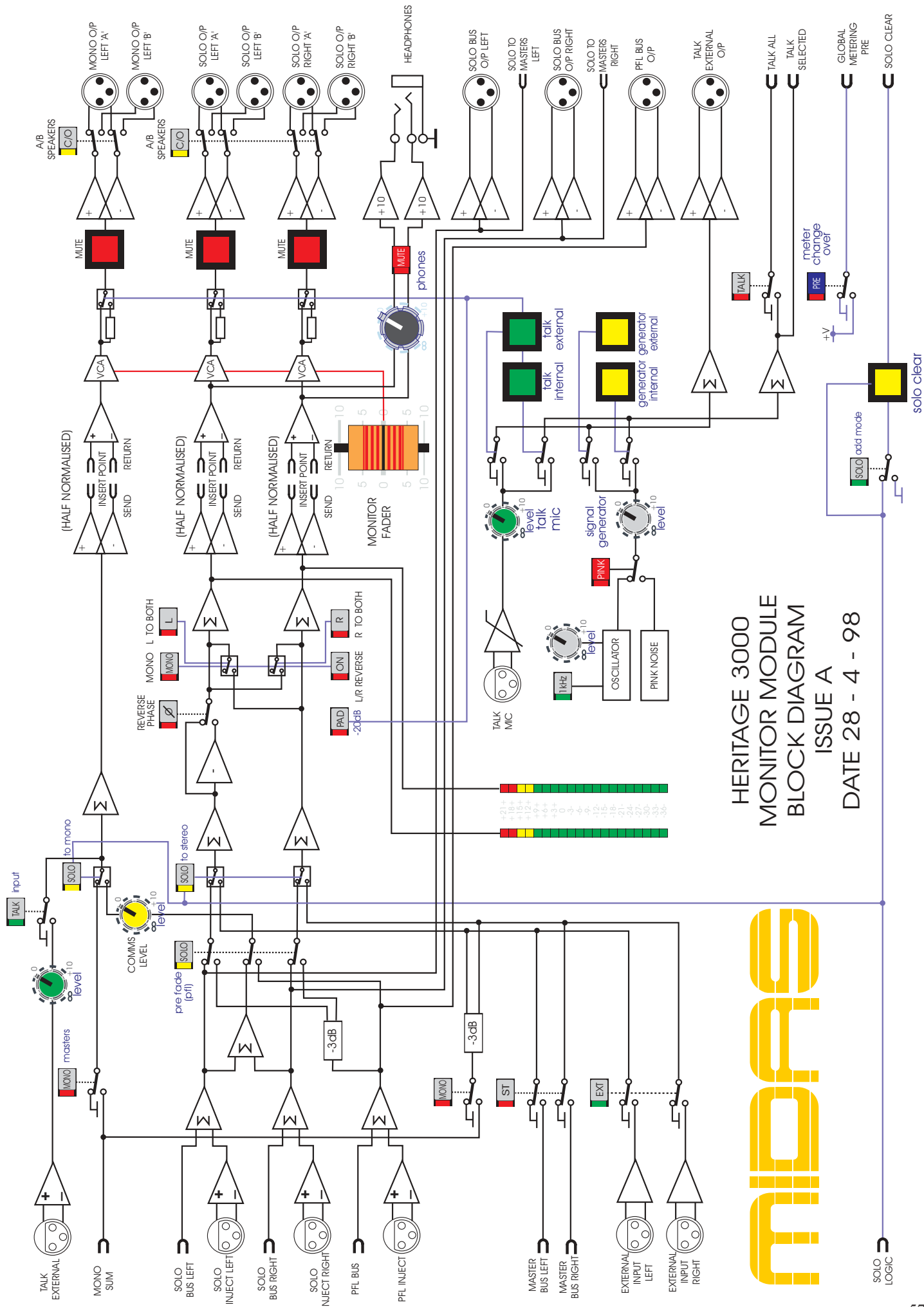

HERITAGE 3000
MONITOR MODULE
BLOCK DIAGRAM
ISSUE A

DATE 28 - 4 - 98

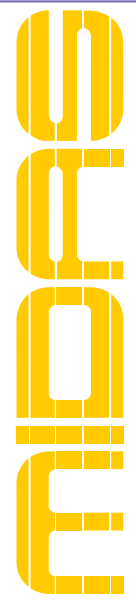

Heritage 3000 Specification Overview and Statistics.

1. The Heritage 3000 is a 30 buss console with an additional 27 x 8 output matrix. The busses are as follows:-

24	stereo or mono configurable groups	= 24
1	stereo master	= 2
1	mono master	= 1
1	stereo AFL	= 2
1	mono PFL	= 1
	TOTAL	= 30

2. The 3000 has 10 automute sub groups and 10 VCA sub groups which include VCA sub group muting.

3. The 3000 has 52 input channels plus an additional 26 direct inputs on the group and master modules.

4. The 3000 has a total XLR input count of 96 as follows:-

52	channel mic inputs
24	group direct inputs
8	matrix bus inject inputs
3	solo bus inject inputs
2	master direct inputs
2	external inputs (2 track return)
1	master bus inject
2	talk mic input
1	talk external input
1	talk int line

5. The 3000 has a total XLR output count of 89 as follows:-

44	input channel direct outputs
24	audio group outputs
8	matrix outputs
3	master outputs
3	solo outputs
6	local outputs
1	talk external output

6. The 3000 has a total of 180 balanced 1/4 inch jacks for inserts as follows:-

52	input channel insert sends
52	input channel insert returns
24	audio group insert sends
24	audio group insert returns
8	matrix insert sends
8	matrix insert returns
3	master insert sends
3	master insert returns
3	local insert sends
3	local insert returns

7. The 3000 has 58 long throw faders for mix control with fader position recall and virtual fader functions.

8. The 3000 has a total of 1043 automated switch functions as follows:-

- 480 input channel VCA sub group virtual assign switches
- 480 input channel mute sub group virtual assign switches
- 48 input channel mute switches
- 24 audio sub group mute switches
- 8 matrix mute switches
- 3 master mute switches

9. The 3000 has a total of 89 peak program meters with 20 LED segments on all outputs and 11 LED segments on input channels.

Heritage 3000 Technical Specifications.

Input Impedance	Mic	2k Balanced
	Line	20k Balanced
Input Gain (all faders at 0dB)	Mic	Continuously variable from + 15dB to + 60dB
	Mic + Pad	Continuously variable from - 10dB to + 35dB
	Line Level Inputs	0dB
Maximum Input Level	Mic	+ 6dBu
	Mic + Pad	+ 31dBu
	Line Level Inputs	+ 21dBu
CMR at 100Hz	Mic (gain at +40dB)	Typ 115dB
	Mic + Pad (gain 0dB)	Typ 80dB
CMR at 1kHz	Mic (gain + 40dB)	> 100dB
	Mic + Pad (gain 0dB)	> 60dB
	Line	> 50dB
Frequency Response (20 to 20kHz)	Mic to Mix (gain + 60dB)	+ 0dB to - 1dB
Noise (20 to 20kHz)	Mic EIN ref. 150 (gain + 60dB)	- 128dBu
System Noise (20 to 20kHz)	Summing Noise (48 channels routed with faders down)	- 80dB
	Line to Mix Noise (48 channels routed at 0dB, pan centre)	- 75dB
Distortion at 1kHz	Mic to Mix (+ 60dB gain, 0dBu output)	< 0.03%

Crosstalk at 1kHz	Channel to Channel	< - 90dB
	Mix to Mix	< - 90dB
	Channel to Mix	< - 90dB
	Maximum Fader attenuation	> 80dB
Output Impedance	All Line Outputs	50 Ohms Balanced Source to drive > 600
	Headphones	To drive > 8
Maximum Output Level	All Line Outputs	+ 21dBu
	Headphones	+ 21dBu
Nominal Signal Level	Mic	- 60dBu to + 10dBu
	Line	0dBu
	Headphones	+ 10dBu
Equaliser	Hi pass slope	12dB / Oct
	Hi pass frequency	Continuously variable - 3dB point from 20Hz to 400Hz
	Treble Gain	Continuously variable + 15 dB to - 15 dB Centre detent = 0dB
	Treble Shelving Freq.	Continuously variable - 3dB point from 1k to 20k
	Treble Bell Freq.	Continuously variable centre from 1k to 20k
	Treble Bell Bandwidth	Continuously variable 0.1 Oct. to 2 Oct Centre detent = 0.5 Oct
	Hi Mid Gain	Continuously variable + 15 dB to - 15 dB Centre detent = 0dB
	Hi Mid Freq.	Continuously variable centre from 400Hz to 8k
	Hi Mid Bandwidth	Continuously variable 0.1 Oct. to 2 Oct Centre detent = 0.5 Oct













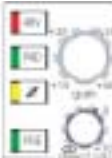





































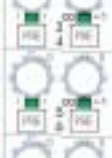
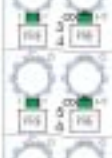
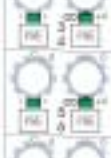

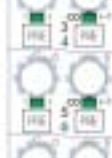

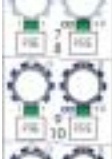



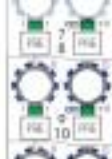
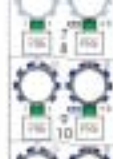

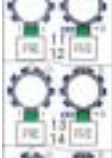
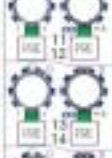

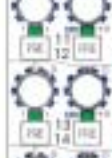
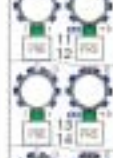
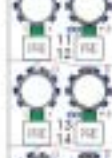

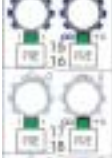

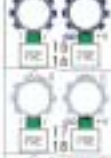
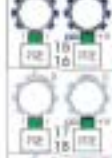
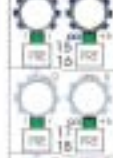
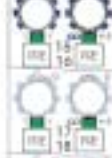
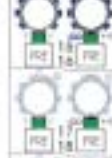
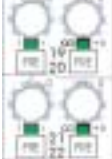



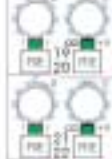
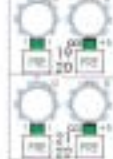
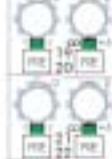

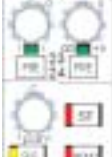
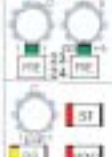
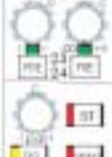
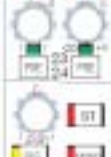
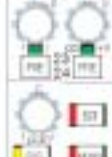

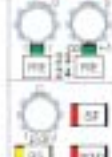
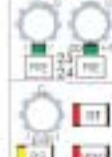
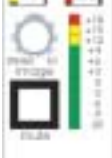

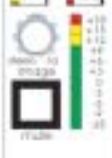
Lo Mid Gain	Continuously variable + 15 dB to - 15 dB Centre detent = 0dB
Lo Mid Freq.	Continuously variable centre from 100Hz to 2k
Lo Mid Bandwidth	Continuously variable 0.1 Oct. to 2 Oct Centre detent = 0.5 Oct
Bass Gain	Continuously variable + 15 dB to - 15 dB Centre detent = 0dB
Bass Shelving Freq.	Continuously variable - 3dB point from 20Hz to 400Hz
Bass Bell Freq.	Continuously variable centre from 20Hz to 400Hz
Bass Bell Bandwidth	Continuously variable 0.1 Oct. to 2 Oct Centre detent = 0.5 Oct

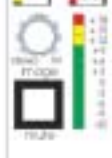
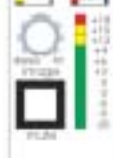
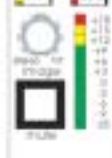
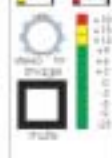

Input Crib Sheet

Inputs
to _____

Notes:

 FE1	 FE2	 FE3	 FE4	 FE5	 FE6	 FE7	 FE8
 FE9	 FE10	 FE11	 FE12	 FE13	 FE14	 FE15	 FE16
 FE17	 FE18	 FE19	 FE20	 FE21	 FE22	 FE23	 FE24
 FE25	 FE26	 FE27	 FE28	 FE29	 FE30	 FE31	 FE32
 FE33	 FE34	 FE35	 FE36	 FE37	 FE38	 FE39	 FE40
 FE41	 FE42	 FE43	 FE44	 FE45	 FE46	 FE47	 FE48
 FE49	 FE50	 FE51	 FE52	 FE53	 FE54	 FE55	 FE56
 FE57	 FE58	 FE59	 FE60	 FE61	 FE62	 FE63	 FE64
 FE65	 FE66	 FE67	 FE68	 FE69	 FE70	 FE71	 FE72
 FE73	 FE74	 FE75	 FE76	 FE77	 FE78	 FE79	 FE80
 FE81	 FE82	 FE83	 FE84	 FE85	 FE86	 FE87	 FE88
 FE89	 FE90	 FE91	 FE92	 FE93	 FE94	 FE95	 FE96
 FE97	 FE98	 FE99	 FE100	 FE101	 FE102	 FE103	 FE104

Input No

