

User Manual

020-001225-02

GS Series **DHD1075-GS/DWU1075-GS**

CHRISTIE®

The USB included with this printed manual contains an electronic copy in English. Please read all instructions before using or servicing this product.

手册中包含的 U 盘，带有着中文的电子副本，使用或维修本产品前，请仔细阅读所有的指示。

Le clé USB fourni avec ce manuel imprimé contient une copie électronique en français. S'il vous plaît lire toutes les instructions avant d'utiliser ou de réparer ce produit.

Das USB, das mit diesem gedruckten Handbuch eingeschlossen ist, enthält eine elektronische Kopie auf in deutscher Sprache. Vor der Anwendung oder der Instandhaltung dieses Produktes lesen Sie bitte alle Anweisungen.

Il USB fornito con il manuale stampato contiene una copia elettronica in lingua italiano. Si prega di leggere tutte le istruzioni prima di utilizzare o riparare questo prodotto.

この印刷されたマニュアルに同梱されております USB には、日本語での説明書が入っております。この製品を使用あるいは修理点検される際に、ご参照下さい。

매뉴얼과 함께 포함되어 있는 USB 에는 한글로 된 전자사본을 포함하고 있습니다 . 본 제품을 사용 혹은 서비스하기 전에 모든 지침 사항들을 읽어 보시기 바랍니다 .

Поставляемый в комплекте с документацией USB содержит электронную копию руководства пользователя на русском языке. Перед началом использования изделия или проведения сервиса пожалуйста прочтите все инструкции изложенные в руководстве.

El USB incluido con este manual impreso contiene una copia electrónica en español. Por favor, lea todas las instrucciones antes de usar o dar servicio a este producto.

USB, що постачається з цим друковане керівництво містить електронну копію українською мовою. Будь ласка, прочитайте всі інструкції перед використанням або обслуговуванням цього продукту.

O USB incluído com o impresso livro contém um eletrônico cópia em Português. Por favor lido todas as instruções antes de usar ou prestando serviço esse resultado.

NOTICES

COPYRIGHT AND TRADEMARKS

Copyright © 2017 Christie Digital Systems USA Inc. All rights reserved.

All brand names and product names are trademarks, registered trademarks or trade names of their respective holders.

GENERAL

Every effort has been made to ensure accuracy, however in some cases changes in the products or availability could occur which may not be reflected in this document. Christie reserves the right to make changes to specifications at any time without notice. Performance specifications are typical, but may vary depending on conditions beyond Christie's control such as maintenance of the product in proper working conditions. Performance specifications are based on information available at the time of printing. Christie makes no warranty of any kind with regard to this material, including, but not limited to, implied warranties of fitness for a particular purpose. Christie will not be liable for errors contained herein or for incidental or consequential damages in connection with the performance or use of this material. Canadian manufacturing facility is ISO 9001 and 14001 certified.

WARRANTY

Products are warranted under Christie's standard limited warranty, the complete details of which are available by contacting your Christie dealer or Christie. In addition to the other limitations that may be specified in Christie's standard limited warranty and, to the extent relevant or applicable to your product, the warranty does not cover:

- a. Problems or damage occurring during shipment, in either direction.
- b. Projector lamps (See Christie's separate lamp program policy).
- c. Problems or damage caused by use of a projector lamp beyond the recommended lamp life, or use of a lamp other than a Christie lamp supplied by Christie or an authorized distributor of Christie lamps.
- d. Problems or damage caused by combination of a product with non-Christie equipment, such as distribution systems, cameras, DVD players, etc., or use of a product with any non-Christie interface device.
- e. Problems or damage caused by the use of any lamp, replacement part or component purchased or obtained from an unauthorized distributor of Christie lamps, replacement parts or components including, without limitation, any distributor offering Christie lamps, replacement parts or components through the internet (confirmation of authorized distributors may be obtained from Christie).
- f. Problems or damage caused by misuse, improper power source, accident, fire, flood, lightning, earthquake or other natural disaster.
- g. Problems or damage caused by improper installation/alignment, or by equipment modification, if by other than Christie service personnel or a Christie authorized repair service provider.
- h. Problems or damage caused by use of a product on a motion platform or other movable device where such product has not been designed, modified or approved by Christie for such use.
- i. Problems or damage caused by use of a projector in the presence of an oil-based fog machine or laser-based lighting that is unrelated to the projector.
- j. For LCD projectors, the warranty period specified in the warranty applies only where the LCD projector is in "normal use" which means the LCD projector is not used more than 8 hours a day, 5 days a week.
- k. Except where the product is designed for outdoor use, problems or damage caused by use of the product outdoors unless such product is protected from precipitation or other adverse weather or environmental conditions and the ambient temperature is within the recommended ambient temperature set forth in the specifications for such product.
- l. Image retention on LCD flat panels.
- m. Defects caused by normal wear and tear or otherwise due to normal aging of a product.

The warranty does not apply to any product where the serial number has been removed or obliterated. The warranty also does not apply to any product sold by a reseller to an end user outside of the country where the reseller is located unless (i) Christie has an office in the country where the end user is located or (ii) the required international warranty fee has been paid.

The warranty does not obligate Christie to provide any on site warranty service at the product site location.

PREVENTATIVE MAINTENANCE

Preventative maintenance is an important part of the continued and proper operation of your product. Failure to perform maintenance as required, and in accordance with the maintenance schedule specified by Christie, will void the warranty.

REGULATORY

The product has been tested and found to comply with the limits for a Class A digital device, pursuant to Part 15 of the FCC Rules. These limits are designed to provide reasonable protection against harmful interference when the product is operated in a commercial environment. The product generates, uses, and can radiate radio frequency energy and, if not installed and used in accordance with the instruction manual, may cause harmful interference to radio communications. Operation of the product in a residential area is likely to cause harmful interference in which case the user will be required to correct the interference at the user's own expense.

CAN ICES-3 (A) / NMB-3 (A)

이 기기는 업무용 (A 급) 으로 전자파적합등록을 한 기기이오니 판매자 또는 사용자는 이점을 주의하시기 바라며, 가정 외의 지역에서 사용하는 것을 목적으로 합니다.

Environmental

The product is designed and manufactured with high-quality materials and components that can be recycled and reused. **This symbol**  means that electrical and electronic equipment, at their end-of-life, should be disposed of separately from regular waste. Please dispose of the product appropriately and according to local regulations. In the European Union, there are separate collection systems for used electrical and electronic products. Please help us to conserve the environment we live in!

Content

Safety	8
Laser safety warnings	9
Light intensity hazard distance	10
Introduction	11
Projector components	11
Front view	11
Rear view	12
Left view	13
Right view	13
Built-in keypad	14
Input/Output (I/O) panel	15
IR remote keypad	16
LED status indicators	18
Status LED	18
Shutter LED	18
Installation	19
Connecting to a computer	19
Connecting to video equipment	20
Turning the projector on	21
Turning the projector off	21
Adjusting the projector position	22
Calculating the lens offset	23
WUXGA projectors	23
HD Projectors:	25
Removing and installing the lens	27
Installing the ceiling mount	28
Installing the projector in the rigging frame	28
Setup, alignment and test procedures	29
Operation	30
Size and Position menu	31
Geometry correction	33
Image Settings menu	36

- Configuration Menu 39
 - Color matching 44
- Light Source menu 46
- Status menu 47
 - For DHD models 47
 - For DWU models 48
- Input Switching & PIP menu 49
 - PIP/PBP layout and size 50
- Language menu 51
- Test Pattern menu 51
- Web user interface 51
 - Logging on to the web user interface 52
 - Main tab–General 53
 - Main tab–Status 53
 - Main tab–Lens 54
 - Network 55
 - Tools 58
 - Administrator Page 58
 - About Page 59
- Christie Presenter 59
 - Connecting to the Projector 59
 - Installing the Christie Presenter software 61
 - Using the Christie Presenter 63
 - Connecting and searching the network display 64
 - Selecting the display region 65
 - Configuring Christie Presenter 66
 - Managing all connected network displays 67
 - Operating the Card Reader 68

Troubleshooting 71

- No image appears on screen 71
- Incorrectly displayed image 71
- Presentation is not displayed 72
- Unstable or flickering images 73
- Vertical flickering bar 73
- Image is out of focus 73
- Image is stretched 73
- Image is not the correct size 74

Specifications	75
Inputs	76
PIP/PBP compatibility	81
Key features	82
List of components	82
Optional accessories	83
Physical specifications	83
Physical operating environment	84
Power requirements	84
Warnings	84
Regulatory	85
Safety	85
Laser safety	85
Electro-Magnetic Compatibility	85
Environmental	86
Federal Communications Commission (FCC) warning	86
On-screen display tree	87

Safety

Read all safety and warning guidelines before installing or operating the projector.

This projector must be operated in an environment that meets the operating range specification. Use only the attachments and/or accessories recommended by Christie. Use of others may result in the risk of fire, shock, or personal injury.



Warning! Failure to comply with the following could result in death or serious injury.

- Do not look into the projector lens when the laser is on. The bright light may result in permanent eye damage.
- To reduce the risk of fire or electric shock, do not expose this projector to rain or moisture.
- Do not open or disassemble the projector as this may cause electric shock.
- All installation and maintenance procedures must be performed by a Christie qualified technician.
- Keep all combustible material away from the concentrated light beam of the projector.
- Position all cables where they cannot contact hot surfaces or be pulled or tripped over.
- Always power down the projector and disconnect all power sources before servicing or cleaning.
- Disconnect the power plug from the AC outlet if the product is not being used for an extended period of time.
- Only use the AC power cord supplied. Do not attempt operation if the AC supply and cord are not within the specified voltage and power range for your region.
- Do not allow anything to rest on the power cord.
- Do not block the ventilation slots and openings on the projector.



Caution! Failure to comply with the following could result in minor or moderate injury.

- Only Christie qualified technicians are permitted to open product enclosures.
- FIRE HAZARD! Do not use a power cord or that appears damaged.
- FIRE OR SHOCK HAZARD! Do not overload power outlets and extension cords.



Notice. Failure to comply with the following may result in property damage.

- Use a soft cloth moistened with a mild detergent to clean the display housing.
- Remove the lens plug from the lens opening in the projector before installing the lens. Retain the lens plug to protect the optical components from dust and debris during transport.
- Do not use abrasive cleaners, waxes, or solvents to clean the projector.

Laser safety warnings

This product is classified as CLASS 1 LASER PRODUCT - RISK GROUP 2 according to IEC 60825-1 : 2014 complies with FDA regulations 21 CFR 1040.10 and 1040.11 as a Risk Group 2 , LIP (Laser Illuminated Projector) as defined in IEC 62471:2006 except for deviations pursuant to Laser Notice No. 50, dated June 24, 2007.

 <p>Complies with 21 CFR 1040.10 and 1040.11 as a Risk Group 2, LIP (Laser Illuminated Projector) as defined in IEC 62471:2006 except for deviations pursuant to Laser Notice No. 50, dated June 24, 2007</p>				
<p>IEC 60825-1:2014 CLASS 1 LASER PRODUCT RISK GROUP 2</p>	<p>IEC 60825-1:2014 PRODUIT LASER DE CLASSE 1 GROUPE DE RISQUE 2</p>	<p>IEC 60825-1:2014 1級雷射產品 危險等級2</p>	<p>IEC 60825-1:2014 1등급 레이저 제품 위험 그룹 2</p>	<p>IEC 60825-1:2014 クラス1レーザー製品 リスクグループ2</p>
<p>CAUTION Possibly hazardous optical radiation emitted from this product. Do not stare at beam. May be harmful to the eye.</p>	<p>AVERTISSEMENT Radiation optique à danger potentiel émise par ce produit. Ne regardez pas directement le faisceau laser. Ceci pourrait être nocif pour votre œil.</p>	<p>注意 此產品可能會產生有害雷射光，請勿直視光束，避免對眼睛造成傷害。</p>	<p>주의 이 제품으로부터 인체에 위험한 광선이 방사될 수 있음. 광원을 정면으로 바라보지 마시오. 눈에 심각한 손상을 입을 수 있음.</p>	<p>注意 本製品より危険となりうる光放射あり。ビームをのぞき込まないこと。眼に有害となる可能性あり。</p>

Pinching hazard



RG2 caution symbol



Warning! Failure to comply with the following could result in death or serious injury.

- This projector has a built-in Class 4 laser module. Never attempt to disassemble or modify the projector.
- Any operation or adjustment not specifically instructed in the User manual creates the risk of hazardous laser radiation exposure.
- Do not open or disassemble the projector as this may cause damage or exposure to laser radiation.
- Do not stare into beam when the projector is on. The bright light may result in permanent eye damage.
- When turning on the projector, make sure no one within projection range is looking into the lens.
- Follow the control, adjustment, or operation procedures to avoid damage or injury from exposure of laser radiation.
- The instructions for the assembly, operation, and maintenance include clear warnings concerning precautions to avoid possible exposure to hazardous laser radiation.

Light intensity hazard distance

This projector has been classified as CLASS 1 LASER PRODUCT - RISK GROUP 2 due to possible hazardous optical and thermal radiation being emitted.



Warning! Failure to comply with the following could result in serious injury.

- PERMANENT/TEMPORARY BLINDNESS HAZARD! No direct exposure to the beam must be permitted. RG2 IEC 62471-5:2014.
- PERMANENT/TEMPORARY BLINDNESS HAZARD! Operators must control access to the beam within the hazard distance or install the product at the height (greater than or equal to 3.0 m from the floor to the beam) that prevents exposure of spectators' eyes within the hazard distance.
- EXTREME BRIGHTNESS! Do not place reflective objects in the product light path.
- Do not stare into beam when the projector is on. The bright light may result in permanent eye damage.

Introduction

The 1075-GS Series is a high brightness, high-resolution video graphics one-chip laser-based projector. The projector is available in HD and WUXGA resolutions and uses Digital Light Processing (DLP®) technology from Texas Instruments. It is primarily designed for fixed installation and secondary applications including rental-staging and LBE (Location Based Entertainment). This product is used for professional applications and is not for domestic use.

Projector components

Identify the main components of the projector.

Front view

Identify the main components on the front of the projector.

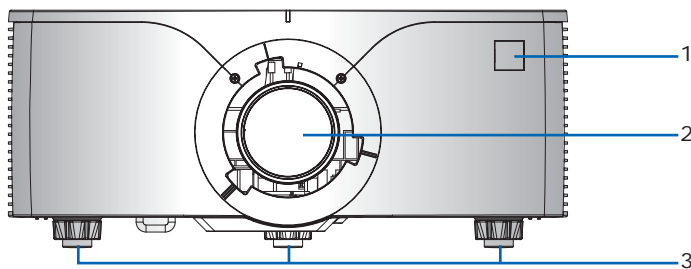

ID	Part name	Description
1	Front IR sensors	Receives signals from the IR remote keypad. Keep the signal path to the sensor unobstructed for uninterrupted communication with the projector.
2	Projection lens	Allows automated lens control and adjustment: vertical and horizontal offsets, zoom, and focus.
3	Adjustable feet	Raises or lowers the feet to level the projector.

Rear view

Identify the main components on the rear of the projector.

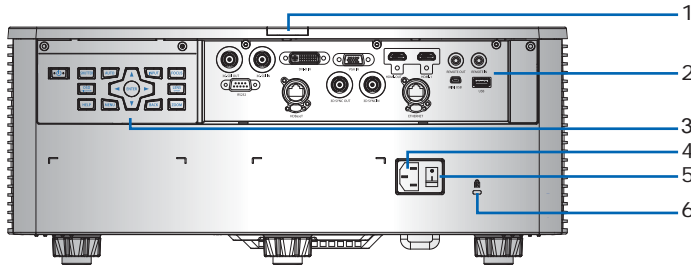

ID	Part name	Description
1	Rear IR sensor	Receives signals from the IR remote keypad. Keep the signal path unobstructed for uninterrupted communication with the projector.
2	Input/Output (I/O) panel	Connects the projector to external devices.
3	Built-in keypad	Controls the projector.
4	AC input	Connects to the supplied power adapter.
5	Power button	Powers the projector on or off.
6	Kensington Security Slot	Secures the projector to help prevent theft or unauthorized removal.

Left view

Identify the main components on the left side of the projector.

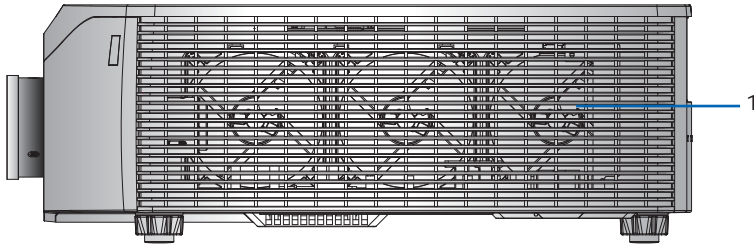

ID	Part name	Description
1	Cooling air vents (intake)	Provides cooling to the projector. Keep these vents unobstructed to prevent the projector from overheating.

Right view

Identify the main component on the right side of the projector.

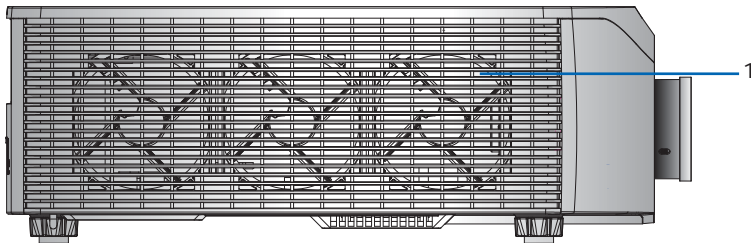

ID	Part name	Description
1	Cooling air vents (exhaust)	Provides cooling to the projector. Keep these vents unobstructed to prevent the projector from overheating.

Built-in keypad

The built-in keypad controls the projector.

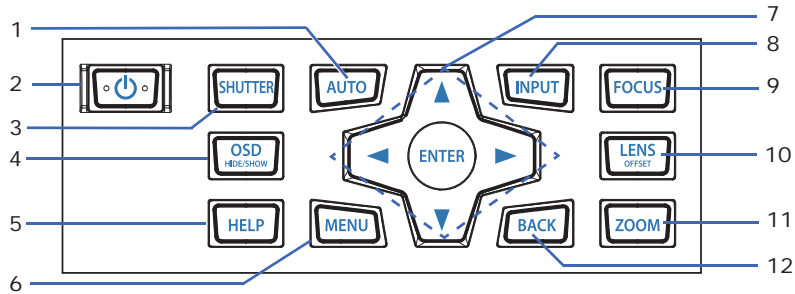

ID	Part name	Description
1	Auto	Automatically optimizes an image.
2	Power	Turns the projector on or off.
3	Shutter	Displays or blanks the video image.
4	OSD	Hides or shows the on-screen display (OSD) menus.
5	Help	Displays the instructions for source connection.
6	Menu	Displays the menus.
7	Arrow keys	Adjusts a setting up or down, or navigates within a menu.
8	Input	Selects an input for the main or PIP/PBP image.
9	Focus	Adjust the focus.
10	Lens	Adjusts the lens vertical or horizontal offset setting.
11	Zoom	Adjusts the zoom.
12	Back	Returns to the previous level or exits the menus if at top level.

Input/Output (I/O) panel

Identify the components of the Input/Output (I/O) panel.

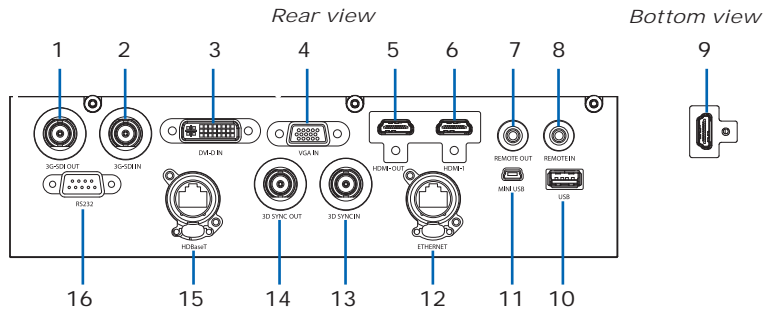

ID	Connector name	ID	Connector name
1	3G-SDI OUT	9	HDMI-2
2	3G-SDI IN	10	USB
3	DVI-D IN	11	MINI USB
4	VGA IN	12	ETHERNET
5	HDMI-OUT	13	3D SYNC IN
6	HDMI-1	14	3D SYNC OUT
7	REMOTE OUT	15	HDBaseT
8	REMOTE IN	16	RS232

IR remote keypad

The IR remote keypad communicates with the projector by way of wireless or wired connection. For wired connection, use a cable length of 20 m or less. If the length of cable exceeds 20 m, the IR remote keypad may not work correctly.

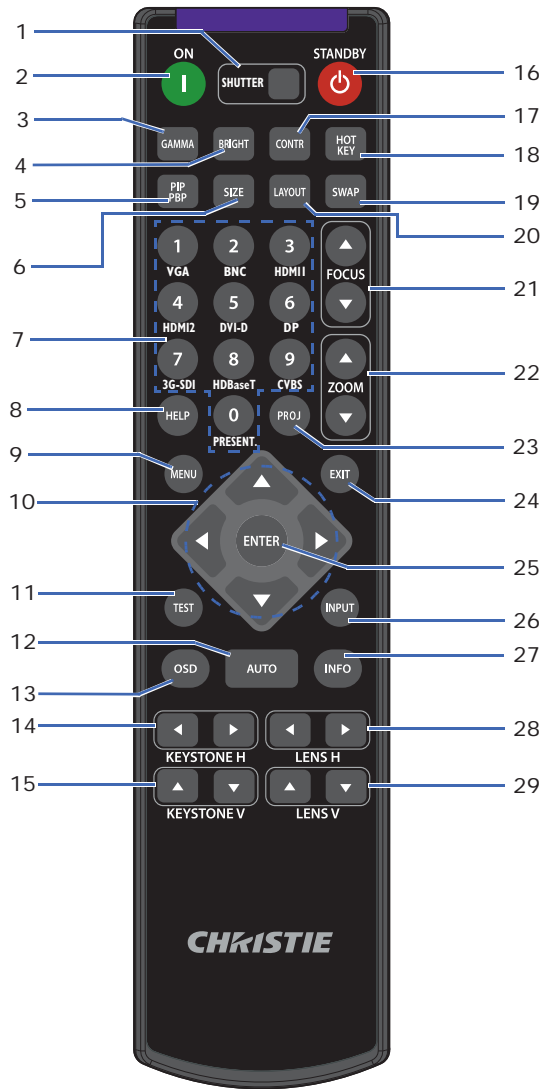

ID	Button	Description
1	SHUTTER	Displays or blanks the video image.
2	ON	Turns the projector on.
3	Gamma	Adjusts the mid-range levels.
4	BRIGHT	Adjusts the amount of light in the image.
5	PIP/PBP	Turns PIP/PBP on or off.

ID	Button	Description
6	SIZE	Adjusts the PIP/PBP size.
7	Number Keys	Enters a number, such as a channel, value, and so on. The on-screen display indicates if a function is not supported.
8	HELP	Displays the instructions for source connection.
9	MENU	Displays the menus.
10	Arrow keys	Adjusts a setting up or down to navigate within a menu.
11	TEST	Displays a test pattern.
12	AUTO	Automatically optimizes an image.
13	OSD	Uses to hide or shows on-screen display (OSD) menus.
14	KEystone H	Adjusts the horizontal keystone.
15	KEystone V	Adjusts the vertical keystone.
16	STANDBY	Turns the projector off.
17	CONTR	Adjusts the difference between dark and light.
18	HOT KEY	Selects your preset key quickly.
19	SWAP	Swaps the main and PIP/PBP images.
20	LAYOUT	Adjusts the PIP/PBP layout.
21	FOCUS	Adjusts the focus to improve image clarity as required.
22	ZOOM	Adjusts the zoom to achieve a required image size.
23	PROJ	Changes the IR remote keypad ID. <ul style="list-style-type: none"> • To assign an ID, press Proj + <1 to 9>. • To return to the universal IR remote ID, press Proj + 0.
24	EXIT	Returns to previous level or exit menus if at top level.
25	ENTER	Selects a highlighted menu item, or changes or accepts a value.
26	INPUT	Selects an input for the main or PIP/PBP image.
27	INFO	Displays the source image information.
28	LENS H	Adjusts the position of the image horizontally.
29	LENS V	Adjusts the position of the image vertically.

LED status indicators

LEDs are defined below.

Status LED

Identify the LED state colors and meaning.

LED status	Projector state
Off	AC power is off (without AC plugged in).
Green (flashing)	Projector is in startup or cool down mode.
Green (solid)	System is operating normally.
Blue (flashing)	Projector is cooling down.
Blue (solid)	AC has been applied, projector is in standby mode.
Yellow (flashing)	A problem exists with the projector that does not cause it to shut down. Examples of warnings include: filter needs changing, one of the pumps is damaged, or a fan is operating at full speed due to over temperature of LD driver.
Yellow (solid)	The end user is turning off the projector while it is in a warning state.
Red (flashing)	An error with the projector exists that has caused or may inevitably cause it to shut down. Examples of errors include: fan failure, over temperature, wrongly installed filter, color wheel (CW) failure.
Red (solid)	The end user is turning off the projector while it is in an error state.
White (flashing)	Projector is in a flash (LAN) update state.

Shutter LED

Identify the shutter LED state colors and meaning.

LED status	Projector state
Off	Projector is on and an image is displayed. Shutter is open.
Magenta (solid)	Projector is on and the image is blank. Shutter is closed.

Installation

Learn how to install, connect, and optimize the projector display.

Connecting to a computer

Learn what cables/connectors that may be used to connect to various devices.

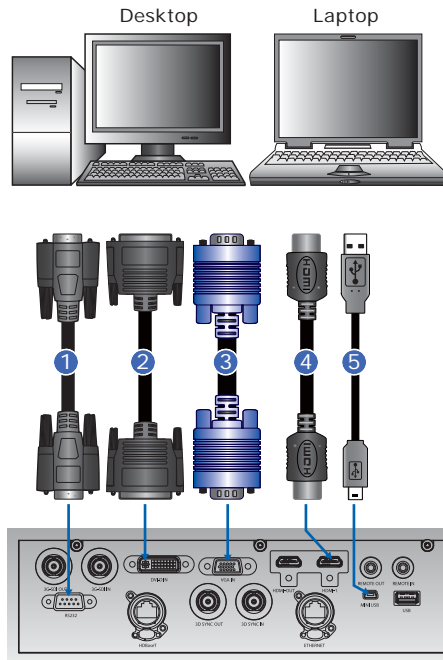

ID	Connector name	ID	Connector name	ID	Connector name
1	RS232 cable	3	VGA IN cable	5	USB Type B mini cable
2	DVI-D IN cable	4	HDMI cable		



- Due to the difference in applications for each country, the accessories required in some regions may differ from those shown.
- This diagram is for illustrative purposes only and does not indicate that these accessories are supplied with the projector.

Connecting to video equipment

Learn what cable/connectors may be used to connect to various devices.

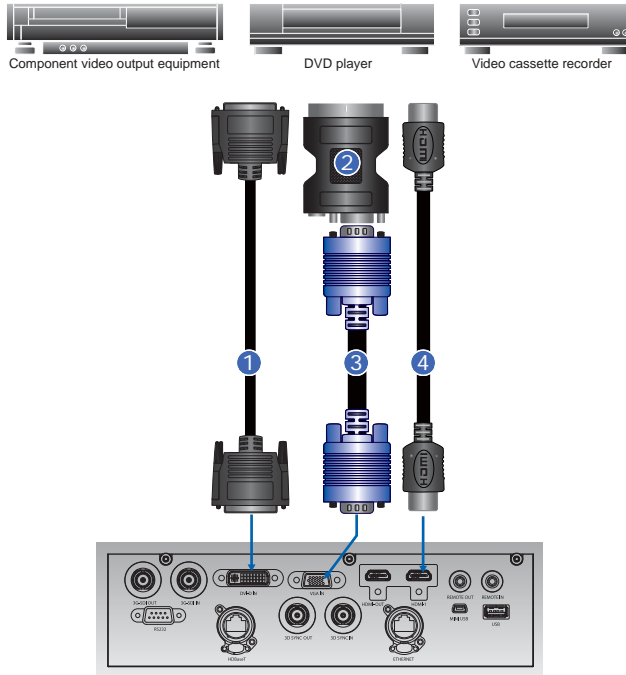

ID	Connector name	ID	Connector name
1	DVI-D IN Cable	3	VGA IN Cable
2	VGA to Component	4	HDMI Cable



- Due to the difference in applications for each country, the accessories required in some regions may differ from those shown.
- This diagram is for illustrative purposes only, and does not indicate that these accessories are supplied with the projector.

Turning the projector on

The projector cables must be securely connected before turning the power on.





Warning! Failure to comply with the following could result in death or serious injury.

- Do not look into the projector lens when the laser is on. The bright light may result in permanent eye damage

1. Connect the projector power cables to AC power.

The Power button on the keypad is illuminated when the power cables are connected.

2. Ensure the lens has been installed in the projector.
3. Ensure that no one or no objects are in the beam path before turning on the projector.
4. To turn on the projector, on the IR remote keypad press  or on the built-in keypad press .

The status LED is green with a slow blink. 

5. To select an input source and turn it on, on the IR remote keypad select **Input Key**. 

Available input sources are VGA, HDMI1, HDMI2, DVI, 3G-SDI, and HD-BaseT.

The projector detects the source you selected and displays the image.

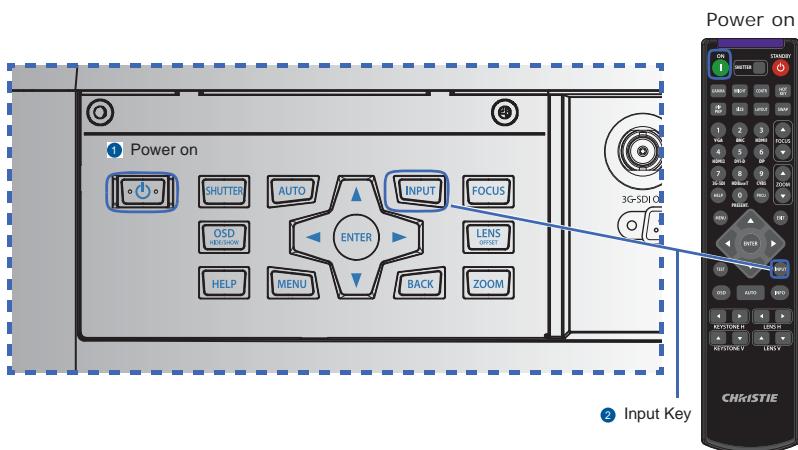

The first time the projector is used, select the preferred language from the Main menu after the startup screen is displayed.

Turning the projector off

Power off the projector in preparation for inspection or maintenance.

1. To turn the projector off, on the IR remote keypad or built-in keypad press .

A warning message appears on the displayed image.

2. To confirm your selection, press **⏻** again.

If you do not press **⏻** again, the warning message disappears after three seconds and the projector remains on.

Adjusting the projector position

When you select a position for the projector, consider the size and shape of your screen, the location of your power outlets, and the distance between the projector and the rest of your equipment. Follow these general guidelines:

- Position the projector on a flat surface at a right angle to the screen. The projector (with the standard lens) must be at least 4.27 feet (1.3 m) from the projection screen.
- Position the projector to the required distance from the screen. The distance from the lens of the projector to the screen, the zoom setting, and the video format determine the size of the projected image.
- Determine the lens throw ratio:
 - Lens 0.75~0.95 (WU/HD)
 - Lens 0.95~1.22 (WU/HD)
 - Lens 1.22~1.53 (WU/HD)
 - Lens 1.52~2.89 (WU/HD)
 - Lens 2.9~5.5 (WU/HD)
 - Lens 0.36 (120" screen, WU/HD)
- 360 degree free orientation operation

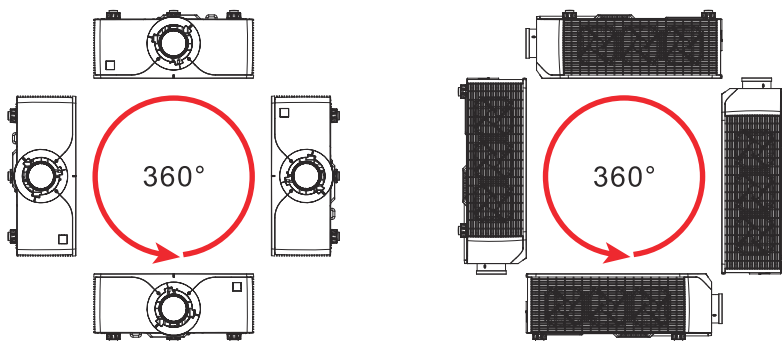

Calculating the lens offset

Adjust the offset to align the image on the screen with half image size.

- The vertical image offset (shift) ranges for the projector are +/-100% (WUXGA) and +/-120% (HD).
- The horizontal image offset (shift) range for the projector is +/-30% (HD/WUXGA).
- The method for calculating lens offset complies with industry standards. For example for vertical lens offset:
 - At 0% offset (or on axis), the center of the image is on the lens center, so half of the image appears above and half appears below the lens center.
 - At +100% offset, the entire of the image appears above the lens center.
 - The percentage (%) offset is calculated as the ratio of the number of pixels shifted up or down to half image size.



UST lens do not support the lens shift function.

WUXGA projectors

The following show vertical image offsets for the WUXGA projectors:

- Vertical image offset: 0%

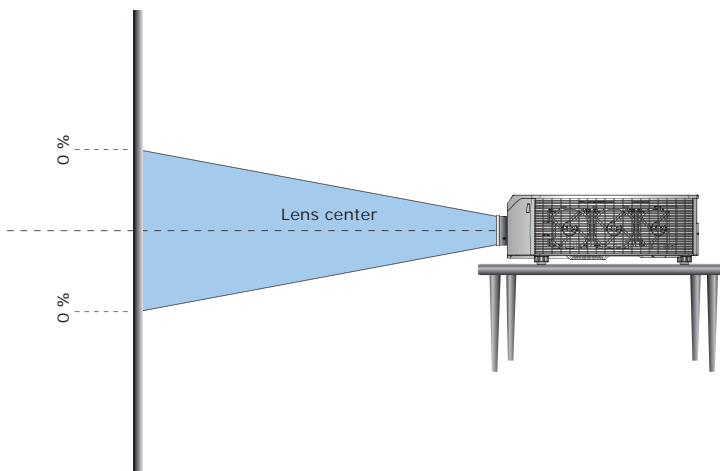

- Vertical image offset: +100%

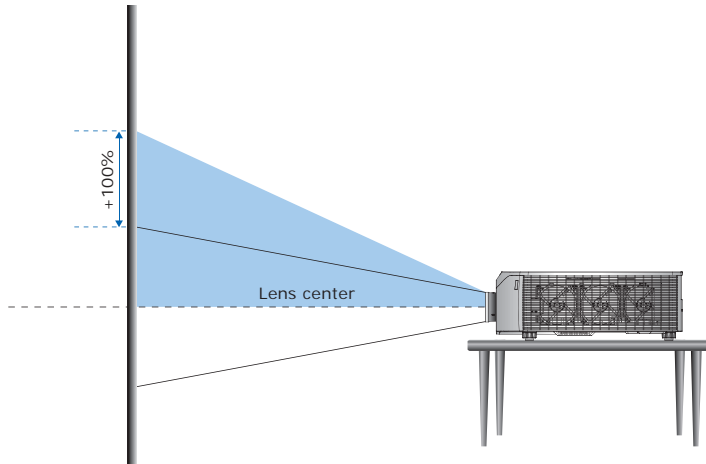

- Vertical image offset: -100%

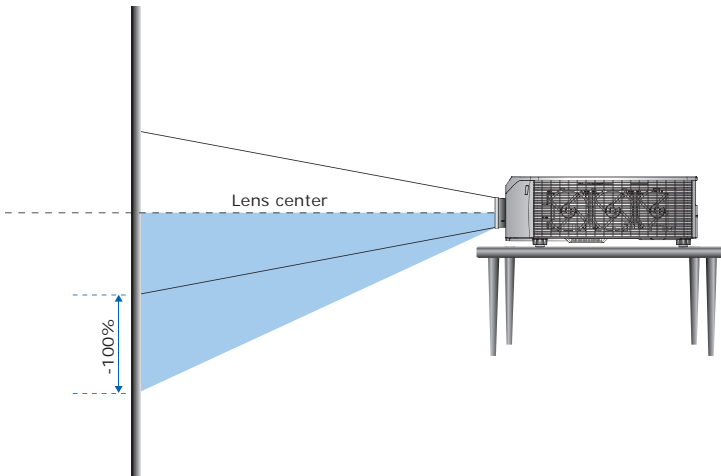

HD Projectors:

The following show vertical and horizontal image offset for HD projectors:

- Vertical image offset: +120%

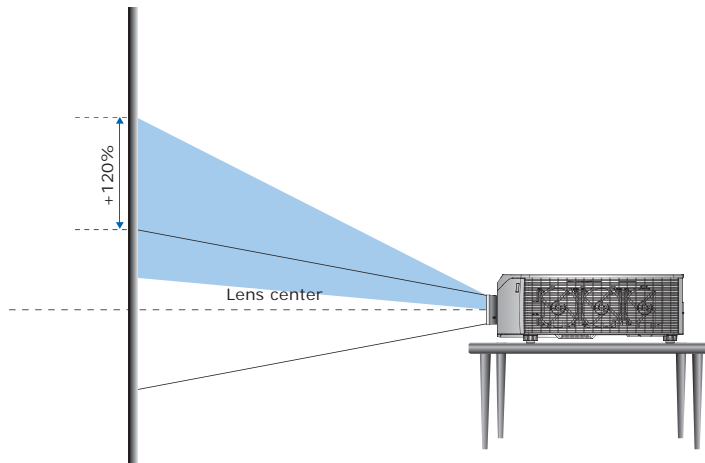

- Vertical image offset: -120%

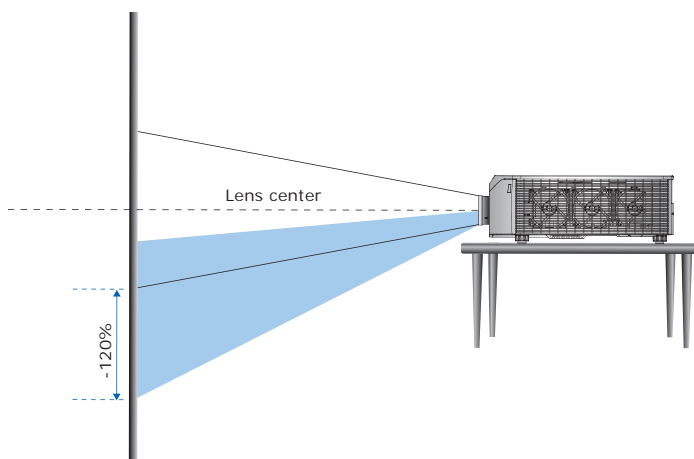

- Horizontal image offset: +/-30%

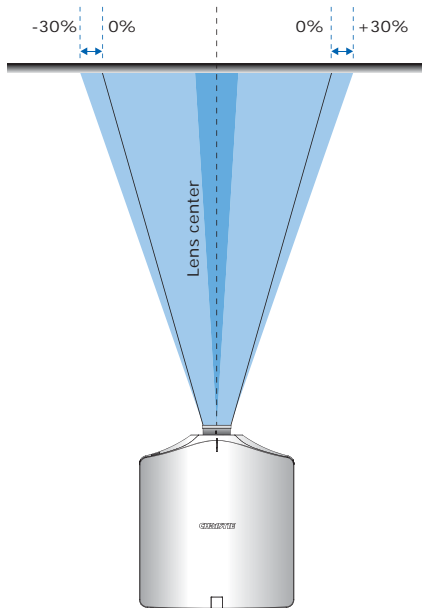

Removing and installing the lens

When handling the projector after lens installation, make sure the front lens cap is placed on the lens to protect the lens surface from potential damage. When carrying or moving the projector, do not handle by the lens. This may damage the lens, the chassis, or other mechanical parts within the projector.

1. Center the lens. Ensure the lens is at or near its center position. Attempting to remove the lens with a large offset may cause damage to the lens assembly.

Center the lens while the projector is switched on by pressing the **Lens Horizontal** or **Lens Vertical** button and then pressing **Enter**.

2. Turn off the projector.
3. Allow the projector to cool down into standby mode before replacing the lens.
4. After the projector has cooled down and prior to replacing the lens, remove the power cord.
5. To remove the lens, press the **Lens Release button** **A** by hand or with a tool and rotate the lens counterclockwise by a quarter **B** to release the lock.

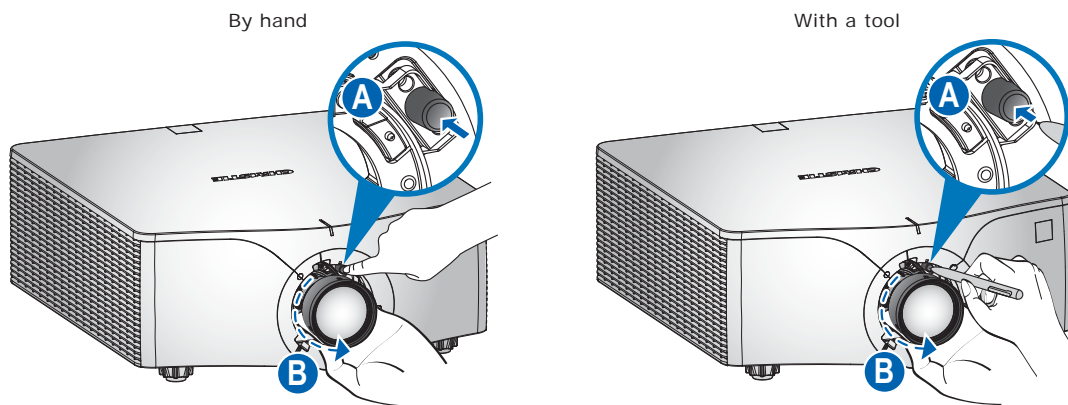

6. Remove the lens through the front of the projector.
7. To install the new lens, fully insert the lens assembly straight into the lens mount **A** without turning.
8. To lock the lens in place, rotate the lens clockwise **B**.

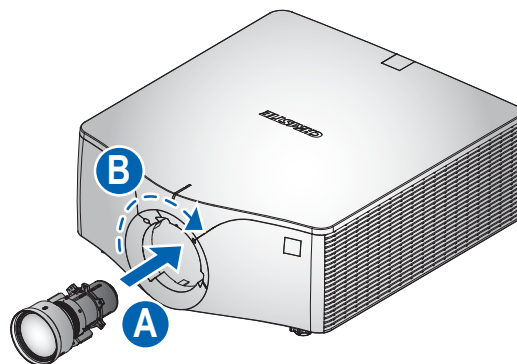



- Notice.** Failure to comply with the following may result in property damage.
- Refer to the UST lens instruction sheet for UST lens installation.

Installing the ceiling mount

Mount the projector with a Christie-approved mount, using the four mounting points on the underside of the projector.

See *Optional accessories* on page 83.



Warning! Failure to comply with the following could result in death or serious injury.

- The projector must be mounted securely according to the ceiling mount instructions.
- The warranty on this projector does not cover damage caused by the use of a non-recommended ceiling mount kit or installation of the ceiling mount kit in an improper location.

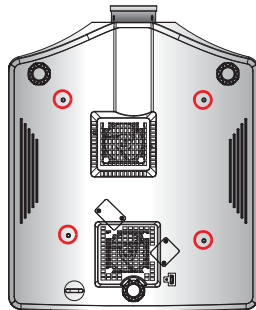

1. Refer to the installation instructions and safety guidelines provided in the mount kit.
See *Optional accessories* on page 83.

Installing the projector in the rigging frame

Install the projector in a Christie-approved rigging frame, using the four mounting points on the underside of the projector.

See *Optional accessories* on page 83.



Warning! Failure to comply with the following could result in death or serious injury.

- The warranty on this projector does not cover damage caused by the use of a non-recommended rigging frame kit or installation of the ceiling mount kit in an improper location.
- The projector must be mounted securely according to rigging frame instructions.

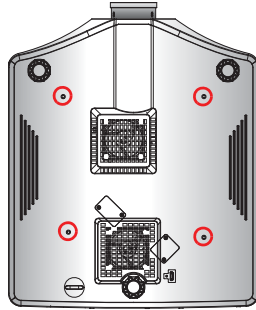

1. Refer to the installation instructions and safety guidelines provided in the rigging frame kit. See *Optional accessories* on page 83.

Setup, alignment and test procedures

Follow the steps for the initial setup, alignment and test procedures.

1. Ensure all appropriate agencies have been notified.
2. Ensure that all required documentation is present at show site.
3. Hang appropriate laser area warning signage (if applicable).
4. Ensure all laser equipment is securely and rigidly mounted.
5. Ensure all cables are appropriately dressed and covered to prevent tripping or other hazards.
6. Perform visual inspection of projector for damage and other issues.
7. Notify and remove all non-essential personnel from fixed radiation area.
8. Check operation of safety features such as, shutters and labels.
9. Check all radiation areas for safe emission condition to ensure no people or objects are obstructing the beam path.
10. Power on lasers.
11. Open shutter and ensure proper operation of laser projector.
12. Use and fill-in Checklist for laser install.
13. Evaluate, discuss and address possible safety concerns.
14. Power off lasers.
15. Ensure operating procedures and checklists are current

Operation

The projector has multilingual on-screen display (OSD) menus so you can make image adjustments and change a variety of settings.

Most of the projector controls are accessed from within the projector menu system. Several groups of related functions are selectable from the Main menu as shown below.

1. To display the Main menu, on the IR remote keypad or on the built-in keypad on the rear of the projector, press **MENU**.
2. To navigate within the menu and adjust a setting up or down, use the arrow keys.
3. To select a highlighted menu item or use it to change or accept a value, press **ENTER**.
You can then select the next item that you want to adjust in the menu.
4. To return to the previous menu or exit menus if at top level, press **EXIT**.

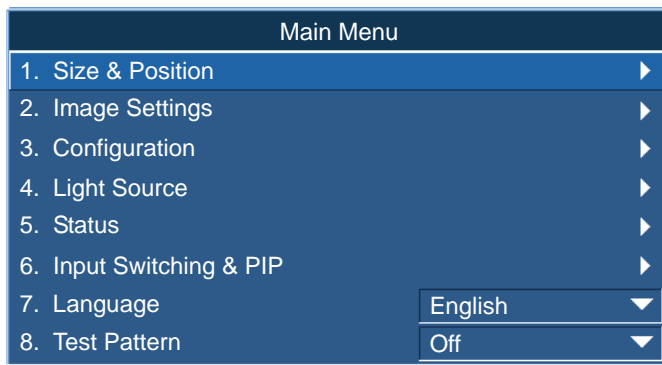

Size and Position menu

The Size and Position menu determines the size and position of the image on the screen.

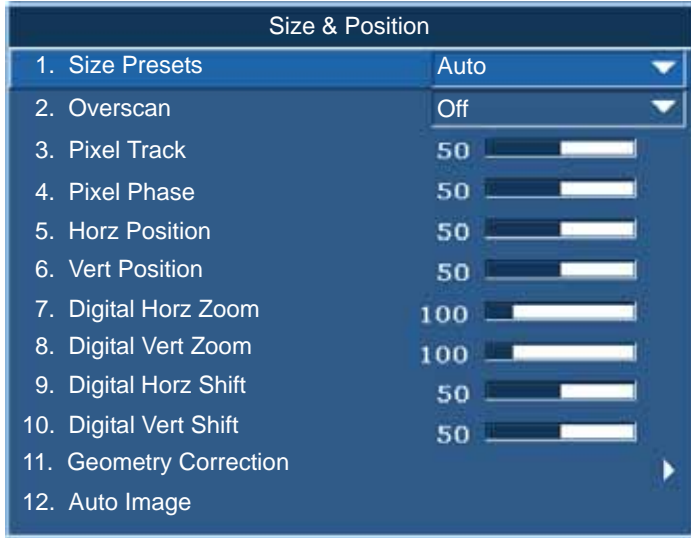

Menu item	Description	Options
Size Presets	Displays an image with the detected size, or resizes the image by maximizing either the height, width, both, or resizes to the maximum size possible while keeping the original aspect ratio.	<ul style="list-style-type: none"> • Auto—Displays with the detected size. • Native—Displays in its native resolution. • 4:3—Retains 4:3 aspect ratio. • Letterbox—Make the active content enlarge to the full screen. • Full Size—Fills the screen (regardless of the source). • Full Width—Fills display width and keep aspect ratio. • Full Height—Fills display height and keep aspect ratio. • Custom—Stretches the display horizontally or vertically without cutting the image display. • 3D Mode—Displays 3D content. If 3D Mode is selected, all other Size Presets items are grayed out.
Overscan	Removes noise around the image.	<ul style="list-style-type: none"> • Overscan Zoom enlarges image 6% from the original size. • Overscan Crop cuts 6% of the active pixels in four edges of original image.

Menu item	Description	Options
Pixel Track	Ensures that the image quality is consistent across the screen, the aspect ratio is maintained, and the pixel phase can be optimized. Steady flickering or several soft vertical stripes or bands across the entire image indicates poor pixel tracking. (Analog RGB signals only)	—
Pixel Phase	Adjusts the pixel phase when the image shows shimmer or noise after pixel tracking is optimized. Pixel phase can adjust the phase of the pixel-sampling clock relative to the incoming signal. (Analog RGB signals only)	—
Horz Position	Moves the image right or left within the area of available pixels.	—
Vert Position	Moves the image up or down within the area of available pixels.	—
Digital Horz Zoom	Changes the size of projector's display area horizontally. If the display area has been resized by this setting, it can be moved by changing the Digital Horz Shift setting.	—
Digital Vert Zoom	Changes the size of projector's display area horizontally. If the display area has been resized by this setting, it can be moved by changing the Digital Vert Shift setting.	—
Digital Horz Shift	Moves the display area horizontally if its size has been changed by the Digital Horz Zoom setting.	—
Digital Vert Shift	Moves the display area vertically if its size has been changed by the Digital Vert Zoom setting.	—
Geometry Correction	Provides two ways for warping control.	<ul style="list-style-type: none"> • PC Mode off—User can do simple horizontal and vertical keystone, pincushion, and 4-corner control by using the on-screen display. • PC Mode on—User can do arbitrary warping or blending control by using PC APP provided separately.
Auto Image	Forces the projector to reacquire and lock to the input signal. This is useful when signal quality is marginal.	<ul style="list-style-type: none"> • Normal mode—Supports all of the 4:3 input sources. • Wide mode—Supports all of the 16:9 input source and most of the 4:3 input source. For the 4:3 input sources not recognized by Wide mode (for example, 1400 x 1050), perform Auto Image using Normal mode.

Geometry correction

Geometry correction provides two ways for warping control:

- PC Mode off—User can do simple horizontal and vertical keystone, pincushion, and 4-corner control by using the on-screen display.
- PC Mode on—User can do arbitrary warping or blending control by using the PC APP provided separately.

The following table provides information about the geometry correction feature compatibility:

Warp Function	4-Corner	Keystone	Pincushion
4-Corner	--	✓	✓
Keystone	✓	--	✓
Pincushion	✓	✓	--

Horz Keystone

Adjust the keystone horizontally to make the image more square. Horz Keystone corrects a keystone image shape in which the left and right borders of the image are unequal in length, and the top and bottom are slanted to one of the sides. Use Horz Keystone with horizontally on-axis applications. For horizontally offset applications, use 4-Corner correction using the on-screen display (OSD) control or the PC App provided separately.

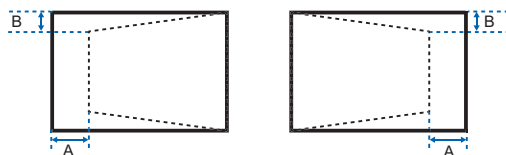

Ind.	1080P	WUXGA
A	30.60%	30.34%
B	14.20%	12.86%

Vert Keystone

Adjust the keystone vertically to make the image more square. Vert Keystone corrects a keystone image shape in which the top and bottom borders of the image are unequal in length, and the left and right are slanted to one of the sides. Use with vertically on-axis applications. For vertically offset images, use 4-Corner correction using the on-screen display (OSD) control or the PC App provided separately.

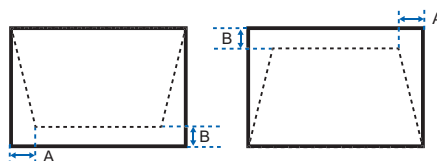

Ind.	1080P	WUXGA
A	5.12%	5.04%
B	11.00%	10.52%

Horz Pincushion

Adjust the pincushion horizontally and make the image more square.

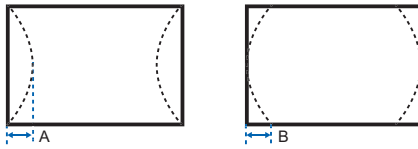

Ind.	1080P	WUXGA
A	5.17%	5.39%
B	5.17%	4.24%

Vert Pincushion

Adjust the pincushion vertically and make the image more square.

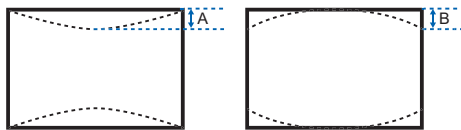

Ind.	1080P	WUXGA
A	9.67%	7.44%
B	9.83%	7.58%

4-Corner

Allow the image to be squeezed to fit an area defined by moving each of the four corners' x and y position.

Ind.	1080P	WUXGA
A	6.25%	6.25%
B	6.67%	6.67%

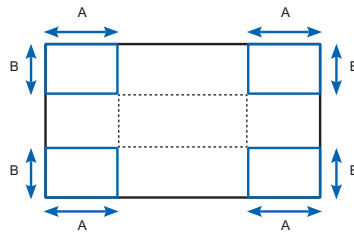

Warp Filter

Warp filter corrects the distorted image, which is caused by projection to a curved surface or by lens distortion.

Auto Warp Filter

- Auto warp filter on—Applies preset warp filter values for distortion correction.
- Auto warp filter off—Disables the warp filter functions.

Manual Warp Filter

- Horz Filter—Adjusts horizontal filter for distortion correction.

- Vert Filter—Adjusts vertical filter for distortion correction.

Reset

Reset all Geometry Correction parameters.

Image Settings menu

The Image Settings menu sets the brightness, contrast, and other settings for images.

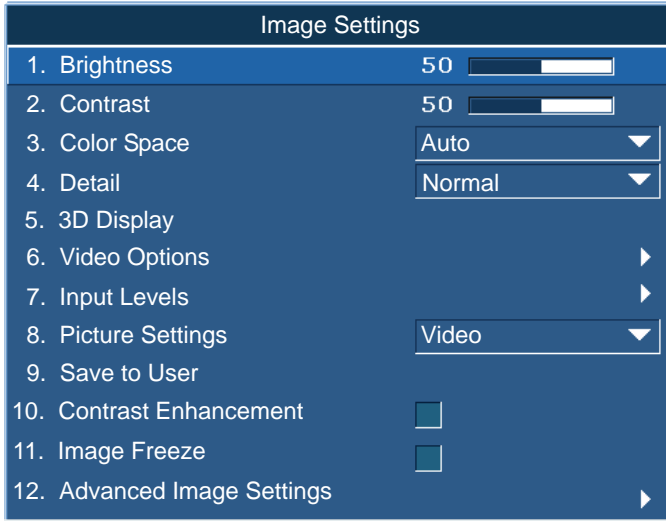

Menu item	Description	Options
Brightness	Adjusts the intensity of the image.	—
Contrast	Adjusts the degree of difference between the lightest and darkest parts of the image and changes the amount of black and white in the image.	—
Color Space	Selects a color space specifically tuned for the input signal. Only useful for analog signals and certain digital sources.	—
Detail	Selects the edge clarity of the image.	—
3D Display	Selects the 3D relating settings.	<ul style="list-style-type: none"> • 3D Enable—Sets the 3D format. Supports mandatory 3D formats and frame sequential 3D@60/120Hz. • 3D Invert—Inverts the 3D sync signal when using a single projector. • Toggle 3D Blending—Inverts 3D sync signal when using multiple projectors for 3D blending. • 3D Sync Out—Transmits a 3D sync signal by the 3D sync output corrector to the emitter or to the next projector for 3D blending purposes. • Frame delay—Corrects asynchronous displaying of images under 3D blending.

Menu item	Description	Options
Video Options	Applies only to video sources.	<ul style="list-style-type: none"> • Color—Adjusts a video image from black and white to fully saturated color. (Video sources only) • Tint—Adjusts the red-green color balance in the image of NTSC video images. (NTSC video sources only) • Detect Film—Controls film mode detection and determine whether the original source of the input video was film or video.
Input Levels	Applies to VGA or component signals only.	<ul style="list-style-type: none"> • Gain—Adjusts the gain of the red, green, or blue channel of the image. It affects the black and white. • Offset—Adjusts the offset of the red, green, or blue channel of the image. It affects the black and white. • Sync Threshold—Helps to sync when connecting to the projector, if a hardware device, such as a DVD player, is not syncing properly with the projector. (Progressive signals only)
Picture Settings	<p>Optimizes the projector for displaying images under certain conditions, such as:</p> <ul style="list-style-type: none"> • Presentation • Video • Bright • Enhanced • REC709 • Real • DICOM SIM • 2D High Speed • 3D • Blending • User-definable preset. <p>It affects the following:</p> <ul style="list-style-type: none"> • Gamma • Sharpness • White Peaking • Overscan • Brightness • Contrast • Color • Tint • Red Gain • Green Gain • Blue Gain • Red Offset • Green Offset 	—

Menu item	Description	Options
Save to User	<p>Saves the user settings.</p> <p>Adjust the image settings and Select Save to User as a picture setting. To recall these settings in the future, select the User in the Picture Settings menu.</p> <p>You can save the following settings:</p> <ul style="list-style-type: none"> • Brightness • Contrast • Color • Tint • Red Gain • Green Gain • Blue Gain • Red Offset • Green Offset • Blue Offset • Color Temperature • Gamma • Detail • White Peaking • Overscan 	—
Contrast Enhancement	<p>Enables or disables the contrast enhancement function. Enable this function to raise the contrast ratio.</p>	<ul style="list-style-type: none"> • DynamicBlack™— Auto adjusts the contrast ratio for video contents. • RealBlack— Reduces the black level for dark images to raise the contrast ratio.
Image Freeze	<p>Pauses the screen image.</p>	—
Advanced Image Settings	<p>Provides access to advanced image settings such as gamma, white peaking, and so on.</p>	<ul style="list-style-type: none"> • Gamma—Selects the appropriate gamma from Video, Film, Bright, CRT, and DICOM. • White Peaking—Increases the brightness of whites near 100%. (Video source only) • Color Temperature—Changes the intensity of the colors. Select a listed relative warmth value. • Edge Enhancement—Applies the edge enhancement process. • Color Wheel Speed—Selects the color wheel speed from 2x or 3x. The color wheel speed defines the delay between the color wheel and the DMD. The higher the speed, the less rainbow effect on the screen.

Configuration Menu

The Configuration menu sets the language, projection orientation, power usage, and other preferences for the projector.

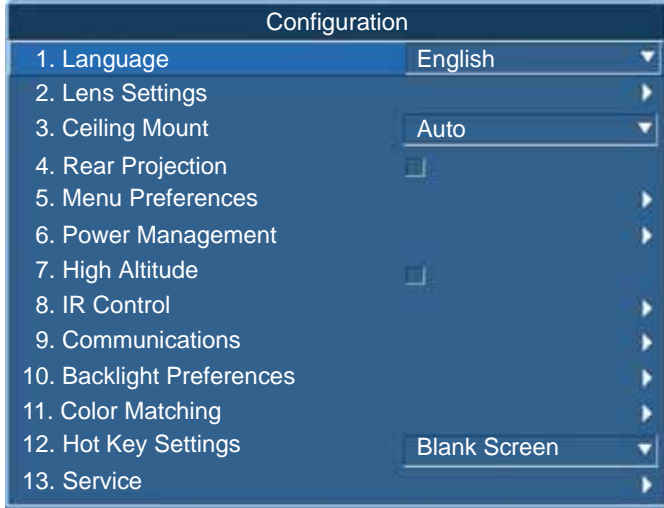

Menu item	Description	Options
Language	Selects an available language for the on-screen display.	<ul style="list-style-type: none"> • English • French • German • Italian • Spanish • Chinese (Simplified) • Japanese • Korean • Russian
Lens Settings	Adjusts the lens.	<ul style="list-style-type: none"> • Focus and Zoom—Adjusts the focus and zoom the image in or out. • Lens Shift—Shifts the lens up and down, or left and right. • Lens Shift Memory—Applies lens position according to the chosen set of lens shift memory position. Save the current lens position to the projector memory. • Lock All Lens Motors—Selects this function to prevent all lens motors from moving. It may disable the zoom, focus, horizontal and vertical position settings, locking any changes and overriding all other lens features. This helps to prevent accidental lens position changes in multi-projector installations. • Lens Calibration—Calibrates the lens center.

Menu item	Description	Options
Ceiling Mount	Turns the image upside down for ceiling-mounted projection.	—
Rear Projection	Reverse the image so you can project from behind a translucent screen.	—
Menu Preferences	Sets the on-screen display menu preferences, and the password for the projector.	<ul style="list-style-type: none"> • Menu Horz Offset—Changes the horizontal position of the on-screen display. • Menu Vert Offset—Changes the vertical position of the on-screen display. • Show Messages—Displays status messages on the screen. • Menu Transparency—Changes the on-screen display menu background to be transparent. As the value increases, more of the image behind the menu is visible. • Splash Screen Setup—Selects the splash screen. • PIN Protect—Protects your projector with a password. Once enabled, you must enter the password before you can project an image. • Change PIN—Allows you to change the password.
Power Management	Determines the power modes for the projector.	<ul style="list-style-type: none"> • Standby Mode—Determines if the projector is in standby mode when connected to AC power. • AC Power On—Automatically turns the projector on when electrical power is connected. • Auto Shutdown—Automatically turns the projector off after no signals are detected for a preset number of minutes. If an active signal is received before the projector powers down, the image is displayed. • Sleep Timer—Allows the projector to automatically power off after it has been on for a specified amount of time (two, four, or six hours). • Cool Down—Configure the cool down time period (instantly off, after 1 minute, or after 2 minutes).
High Altitude	Enables or disables high altitude mode.	<ul style="list-style-type: none"> • On—Enables high altitude mode for altitudes \geq 2000 m. The fan operates at high speed to ensure sufficient air flow for high altitudes. • Off—Disables high altitude mode. For altitudes below 2000 m.
IR Control	Enables or disables the IR sensors.	<ul style="list-style-type: none"> • Top—Enables or disables the signal from the top IR sensor. • Front—Enables or disables the signal from the front IR sensor. • HDBaseT—Enables or disables the signal from the HDBaseT Box.

Menu item	Description	Options
Communications	Determines the communication settings such as network setup, serial port information, and so on.	<p>LAN:</p> <ul style="list-style-type: none"> • DHCP—Turns the DHCP on or off. • IP Address—Assigns the network IP address. • Subnet Mask—Assigns the network subnet mask. • Default Gateway—Assigns the network default gateway. • MAC Address—Displays the network MAC address value. • Apply—To save the change of the LAN. <p>WLAN:</p> <ul style="list-style-type: none"> • Enable—Enables or disables the wireless functionality. • Start IP—Assign the start IP address of the wireless network. • End IP—Assign the end IP address of the wireless network. • Subnet Mask—Assign the subnet mask of the wireless network. • Default Gateway—Assign the gateway of the wireless network. • MAC Address—Display the MAC address of the wireless dongle, if there is. • SSID—Display the SSID of the wireless network. <p>Network:</p> <ul style="list-style-type: none"> • Projector Name—Display the name of the projector. • Show Network Message—Enable or disable to display of the network message. • Restart Network—Restart the network. • Network Factory Reset—Restart the network and set the projector name, LAN and WLAN configuration to the default values. For the detail, please see the sector, Network. <p>Serial Port Baud Rate—Selects the serial port and baud rate.</p> <p>Serial Port Baud Rate—Selects the serial port and baud rate.</p> <p>Serial Port Echo—Controls whether the serial port echoes characters.</p> <p>Serial Port Path—Sets the serial port path to RS232 or HDBaseT.</p> <p>Projector Address—Sets the projector address (0 to 9). The projector responds to the IR remote set to the same address as the projector or to the IR remote set to address 0.</p>
Backlight Preferences	Controls the back light behavior and timeout setting for the keypad and status LED.	—

Menu item	Description	Options
Color Matching	<p>Enables the selected method (Manual Adjustment or HSG) to define the precise hue of each primary color component (red, green, blue and white).</p> <p>When one method is enabled, the other method is automatically disabled. For both methods, if Auto Test Pattern is enabled, the solid colored test pattern can be displayed according to the menu item on which you are positioned.</p> <p>For more information on color matching, see Color matching on page 44.</p>	<ul style="list-style-type: none"> • Manual Adjustment—Manually defines the precise hue of each primary color component. • HSG Adjustment—Adjusts the hue, saturation, and gain (HSG) of the projected image. The HSG function independently controls each of the color regions R, G, B, C, M, Y, and W. • Wall Color—Sets the wall color so the projector can enhance the color performance customized for the specific wall.
Hot Key Settings	<p>Assigns a different function to the hot key on the IR remote keypad by highlighting the function in the list and pressing ENTER.</p> <p>Chooses a function that does not already have a dedicated button, and assign the hot key to that function, allowing you to quickly and easily use the chosen function.</p>	—

Menu item	Description	Options
Service	Displays projector information, sets test patterns, error logs, and high temperature warnings.	<ul style="list-style-type: none"> • Projector Info—Displays the current projector settings. (Read-only) • Factory Reset—Restores all settings to their default value. It does not reset network but it resets RS232. • Test Pattern—Sets the required internal test pattern to display. To turn off a test pattern, select Off. • Wheel Index (2X)—Sets the wheel index to Speed 2X. Only use this setting when a new main board is installed, and the picture quality needs to be optimized. • Wheel Index (3X)—Sets the wheel index to Speed 3X. Only use this setting when a new main board is installed, and the picture quality needs to be optimized. • Error Log—Shows the projector error log for debug. • Mode Adjustment—Fine tunes the horizontal (H) and vertical (V) start position for a signal in the EDID timing table and record the values in the system to override the timing table. To keep the settings, before exiting the menu, select Saved to Record. To revert to original timing table settings, manually clear each setting. Factory Defaults do not clear these override settings. • Laser Diode Info—Displays the information of each laser diode bank including its voltage, current, and temperature. • Fan info— Displays RPM information for fans. • Light Source Hours— Adjusts the current light source hours for service. • ADC Calibration <ul style="list-style-type: none"> • Calibration Conditions—Displays the required equipment for ADC Calibration. • ADC Calibration—Calibrates RGB Gain or offset for analog signal only. • Light Sensor—Performs a calibration. A calibration must be performed before using in Rental mode or after a laser diode driver has been replaced. • Burn in— Burn in starts using the format time on/ time off/ cycle. The items mean time on/time off/ cycle. <ul style="list-style-type: none"> • Off • 60/10/2 • 60/10/4 • 60/10/6 • UST Lens Install—Performs the Ultra Short Throw (UST) lens installation process.

Color matching

You may require a unique color gamut (range) for a single projector or application, or you may need to precisely match colors across multiple adjacent displays. Use color matching by Manual Adjustment or HSG to define the precise hue of each primary color component (red, green, blue, and white).

HSG

Hue, Saturation, and Gain (HSG) software controls the color regions R, G, B, C, M, Y, and W independently.

1. Select HSG, select **Color Matching > HSG**.

Hue

Note the following about adjusted hue:

- Adjust the hue independently for each color (R,G,B,C,M, and Y).
- White does not have a hue input.
- A negative hue input provides a clockwise rotation of the color's hue.
- A positive hue input provides a counter-clockwise rotation of the color's hue.
- A zero input does not change the hue of the color.

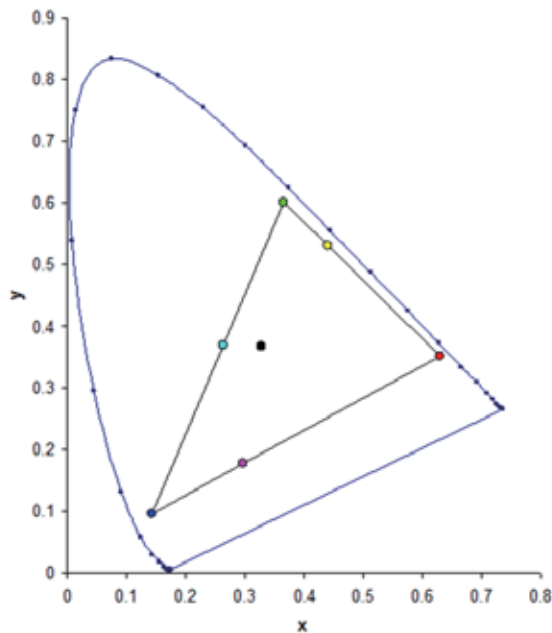

Saturation

Note the following about adjusted saturation:

- The saturation can be adjusted independently for each color (R,G,B,C,M, and Y).
- A saturation level of 0 removes all color from that region.
- A saturation level of 254 sets the color region to have maximum color.
- A saturation level of 127 does not change the saturation.

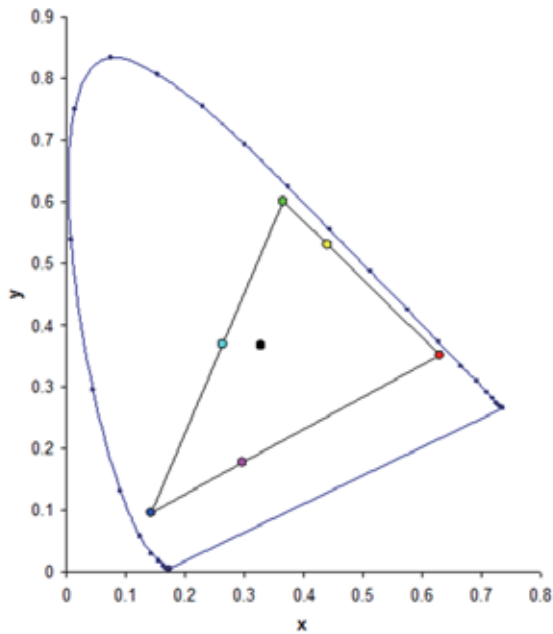

Gain

Note the following about adjusted gain:

- The gain can be adjusted independently for each color (R,G,B,C,M,Y, and W).
- The range of input is 0 to 254.
- The gain changes the intensity level of the respective color.
- A gain level of 127 disables the HSG controls for that color.
- A gain level less than 127 darkens the respective color.
- A gain level of 254 sets the color region to have maximum gain; however, clipping occurs on the signal.
- A gain of 127 is the nominal setting.
- White provides three gain level controls, one each for the R,G,B component of white.

Light Source menu

The Light Source menu sets the light source mode and power preferences.

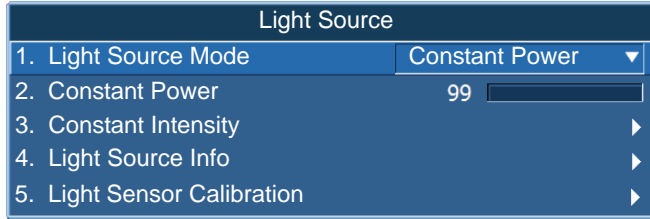

Menu item	Description	Options
Light Source Mode	Sets the light source mode.	<ul style="list-style-type: none"> Constant Power Constant Intensity ECO 1/ECO 2 Rental Mode—Remains at 90% constant brightness and color settings. Light sensor calibration must be performed before enable Rental mode.
Constant Power	Sets the value of the laser diode power.	—
Constant Intensity	<p>Sets the value for the Constant Power mode and change to Constant Intensity mode to maintain constant brightness and color settings.</p> <p>The light sensor monitors the light level and consumes more power than the laser brightness decays naturally over time. When the laser setting sets the maximum power, it remains at this setting for longer period of time than Constant Power mode.</p> <p>Note the following:</p> <ul style="list-style-type: none"> This mode is used for long term projecting or blending purpose. When Constant Intensity is enabled, Dynamic Black and RealBlack function are automatically disabled. When Picture Settings is changed under Constant Intensity mode, it would automatically change back to Constant Power mode. 	—
Light Source Info	Displays information about the light source in the projector.	<ul style="list-style-type: none"> Total Projector Hours—Displays the current total number of hours the projector has been used. LD Hours—Displays the current total number of hours the laser diode has been used.

Menu item	Description	Options
Light Sensor Calibration	Sets the time for light calibration	<ul style="list-style-type: none"> • Default—Processes light calibration at the cooling stage. • Auto—Processes light calibration every 168 hours. • Manual—Indicates that user must perform light calibration manually

Status menu

The read-only Status menu lists a variety of details about the standard and optional components currently detected in the projector.

For DHD models

Status	
Model Name	DHD1075-GS
Serial Number	SB8YYWWXXX
Native Resolution	1920 x 1080
Firmware	V02.00,A02.00,B01.00
Main Input	VGA
Main Signal Format	720P
Main Pixel Clock	74.256MHz
Main Sync Type	Sync On Green
Main Horz Refresh	45.1KHz
Main Vert Refresh	60.0Hz
PIP/PBP Input	-
PIP/PBP Signal Format	-
PIP/PBP Pixel Clock	-
PIP/PBP Sync Type	-
PIP/PBP Horz Refresh	-
PIP/PBP Vert Refresh	-
Light Source Power	99
Total Projector Hours	0
Light Source Hours	0
LC Hours	0
Standby Mode	0.5W Mode
Lens Lock Settings	Allow
IP Address	192.168.0.100
DHCP	No
System Temperature	29 C

For DWU models

Status	
Model Name	DWU1075-GS
Serial Number	SB7YYWWXXX
Native Resolution	1920 x 1200
Firmware	V02.00,A02.00,B01.00
Main Input	VGA
Main Signal Format	720P
Main Pixel Clock	74.256MHz
Main Sync Type	Sync On Green
Main Horz Refresh	45.1KHz
Main Vert Refresh	60.0Hz
PIP/PBP Input	-
PIP/PBP Signal Format	-
PIP/PBP Pixel Clock	-
PIP/PBP Sync Type	-
PIP/PBP Horz Refresh	-
PIP/PBP Vert Refresh	-
Light Source Power	99
Total Projector Hours	0
Light Source Hours	0
LC Hours	0
Standby Mode	0.5W Mode
Lens Lock Settings	Allow
IP Address	192.168.0.100
DHCP	No
System Temperature	29 C

Input Switching & PIP menu

The Input Switching & PIP menu determines how the main and PIP/PBP inputs are handled.

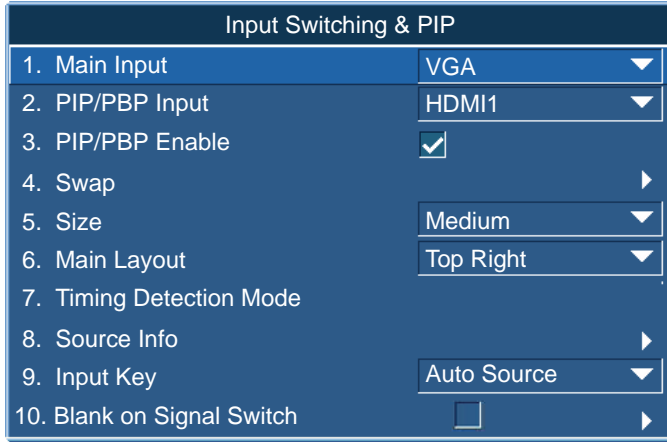

Menu item	Description	Options
Main Input	Selects an active input to be used as the main image.	—
PIP/PBP Input	Selects an active input to be used as the PIP/PBP.	—
PIP/PBP Enable	Toggles between displaying two sources at once (main and PIP/PBP images) or one source only. Refer to <i>Inputs</i> on page 76 and <i>PIP/PBP compatibility</i> on page 81.	<ul style="list-style-type: none"> Selected checkbox—Turns the PIP/PBP source on. Cleared checkbox—Turns the PIP/PBP source off.
Swap	Changes the main image to PIP/PBP, and the PIP/PBP to main image. Swapping is available only when PIP/PBP is enabled.	—
Size	Selects the PIP/PBP size to small, medium, or large.	—
Main Layout	Sets the location of the PIP/PBP image on the screen.	—
Timing Detection Mode	Sets timing detection mode to wide or normal to support additional PC timings. When the projected picture is not completed, this function is used to adjust the picture. For 4:3 input sources not recognized by Wide mode (for example 1400 x 1050), perform Auto Image using Normal mode.	<ul style="list-style-type: none"> Normal mode—Supports 4:3 input sources. Wide mode—Supports the 16:9 input source and most 4:3 input sources.
Source Info	Displays the current source settings. (Read-only)	—
Input key	Lists or changes the sources.	—

Menu item	Description	Options
Blank on Signal Switch	Blanks the screen before timing is stable when changing the source.	<ul style="list-style-type: none"> • On—Blanks the screen before timing is stable when charging source. • Off—Disables blanking the screen.

PIP/PBP layout and size

A P indicates the primary source region (lighter color) and an asterisk (*) indicates both regions are the same size.

PIP/PBP Layout	PIP/PBP Size		
	Small	Medium	Large
PBP, Bigger Left			
Over-Under, Bigger Upper			
PBP, Bigger Right			
Over-Under, Bigger Lower			
PIP-Bottom Right			
PIP-Bottom Left			
PIP-Top Left			
PIP-Top Right			

Language menu

Select an available language for the on-screen display.



Test Pattern menu

Choose the required internal test pattern to display, or select Off to turn off a test pattern.



Web user interface

The web user interface provides an alternate way to access the menu functionality on the projector.

Logging on to the web user interface

Log onto the web user interface by following the steps below.

1. Open a web browser and type the IP address (in the address bar) assigned to your projector.

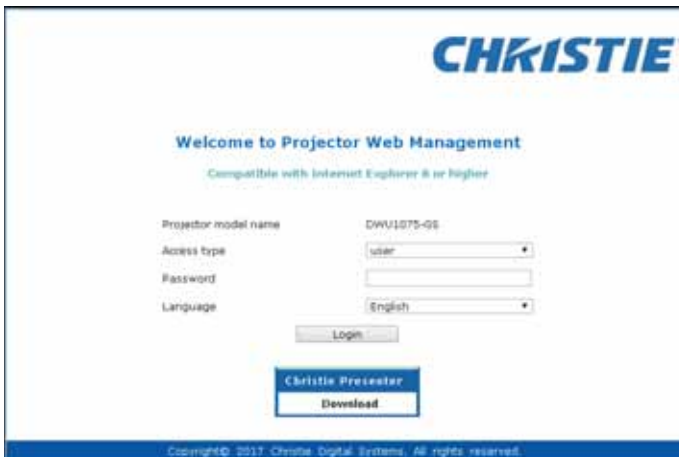

The screenshot shows the Christie Projector Web Management login page. At the top is the Christie logo. Below it is the heading "Welcome to Projector Web Management" and a note "Compatible with Internet Explorer 8 or higher". The form contains the following fields and controls:

- Projector model name: DWV1075-GS
- Access type: A dropdown menu with "user" selected.
- Password: An empty text input field.
- Language: A dropdown menu with "English" selected.
- A "Login" button.
- A "Christie Presenter" button.
- A "Download" button.

At the bottom of the page, there is a copyright notice: "Copyright © 2011 Christie Digital Systems. All rights reserved."

2. From the Access type list, select the log in level.
3. In the Password field, type the password.
4. From the Language list, select the appropriate language.
5. To access the Main window, click **Login**.

Main tab-General

Displays information about the projector, its power status, and what is selected for the main and PIP/PBP input sources.



Panel	Description
Control	Selects main source/PIP source, enables or disables PIP/PBP, changes the layout or PIP size, swap, and change the test pattern.
Projector Information	Checks the projector information for power status, Pic mute status, on-screen display status, IP address, and MAC address.
Switch	Switches the on or off status of Power, Pic Mute, and on-screen display.

Main tab-Status

Displays the current status of light source, cooling (fans), version numbers, and signal (source) information.

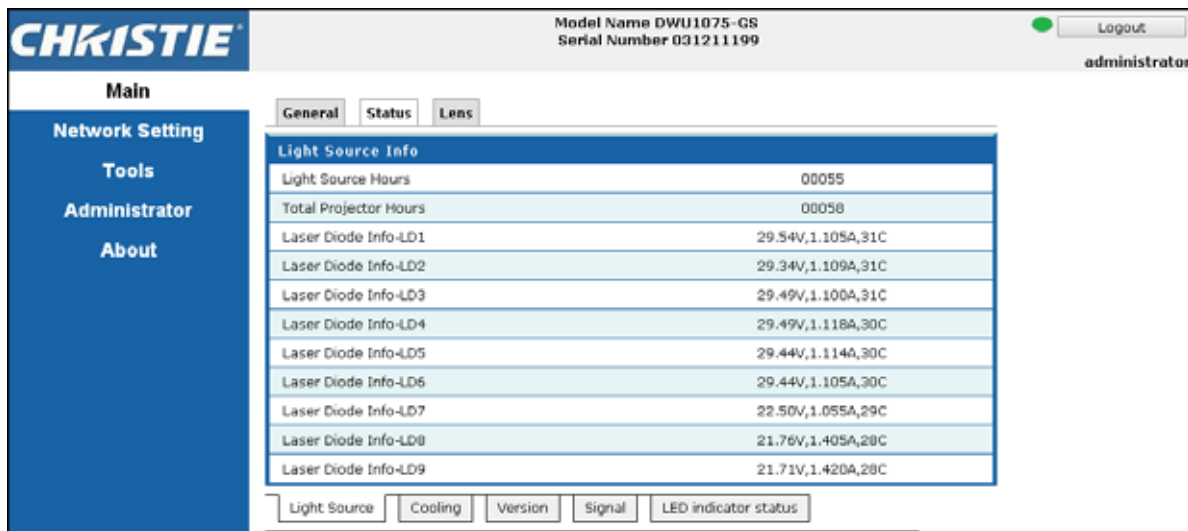

Main tab-Lens

Controls the focus, lens shift, and zoom adjustments for the lens.



Network

If you change a setting, the network subsystem of the projector may restart, and you may be logged off.



Panel	Description	Fields
Restart Network	Executes a network restart. This does not change any of the network settings.	—

Panel	Description	Fields
<p>Network Factory Reset</p>	<p>Executes a network factory reset. Network settings may be reset to the following default values.</p> <p>Projector Name = Christie@ + Serial Number</p> <p>Show Network Messages = ON</p>	<p>LAN settings:</p> <ul style="list-style-type: none"> • Manual • IP Address = 192.168.0.100 • Subnet Mask = 255.255.255.0 • Default Gateway = 192.168.0.100 <p>WLAN settings:</p> <ul style="list-style-type: none"> • Enable • Start IP = 192.168.1.100 • End IP = 192.168.1.120 • Subnet Mask = 255.255.255.0 • Default Gateway = 192.168.1.100 <p>SNMP settings:</p> <ul style="list-style-type: none"> • SNMP Read Community = private • Trap IP Address = 0.0.0.0 • SMTP IP Address = 0.0.0.0 • All other settings are cleared or blanked <p>Trap Configuration:</p> <ul style="list-style-type: none"> • All items = SNMP Trap + Email
<p>LAN Setting Panel</p>	<p>Sets whether the projector must obtain an automatically assigned IP address through DHCP or if the user sets the address manually.</p>	<p>For the TCP/IP setting, enter the IP address, netmask, and default gateway address.</p>
<p>WLAN Setting Panel</p>	<p>Enables or disables the wireless LAN of the projector.</p>	<p>Enter the IP address range, netmask, and default gateway for the wireless LAN.</p>
<p>SNMP Panel</p>	<p>Provides network administrators with a common way to manage their network devices from a single remote location.</p> <p>Administrators can use the Simple Network Management Protocol (SNMP) interface to query a number of devices to see their current status or configuration.</p> <p>Operators can change configuration values and configure trap notifications to be sent when certain events occur (for example, loss of signal, power state change, and so on).</p> <p>Emails are sent to the mail server configured in the projector settings. Up to two user email accounts can be selected. Important information regarding the event is located in the body content of the email.</p> <p>SNMP Traps are notifications sent from the projector and are only received by a trap receiver (MIB Browser) in the computer.</p>	<ul style="list-style-type: none"> • SNMP Read Community (default setting: private)—Plain text password that must also be entered in the MIB browser. This password allows various settings in the projector to be queried. • SNMP Location (default setting: blank)—Use as a description to where a projector is located in a building. SNMP emails sent specify this location. • Trap IP Address (default setting: 0.0.0.0)—Fill in this field with the IP address of the computer, on which you want to view received traps from the projector. • Trap Email 1/2 (default setting: Blank)—Set the Trap Email 1 and 2 to an email address configured under the mail server entered in the SMTP Server IP Address field. • Email from Address (default setting: blank)—Set the name of the source of the SNMP emails. • SMTP Server IP Address (default setting: 0.0.0.0)—Enter the IP address of the mail server.

Panel	Description	Fields
Trap Configuration Panel	Sets the SNMP actions for the system events.	<ul style="list-style-type: none">• SNMP Trap + Email• Email• SNMP Trap• Disabled
Crestron Control System Panel	Provides the information to connect to a Crestron device.	Enter the IP address, IP ID, and port of Crestron device for the connection.

Tools

Use the Tools pages to control size and position, image settings, configuration, light source, input switching, PIP, and test patterns.

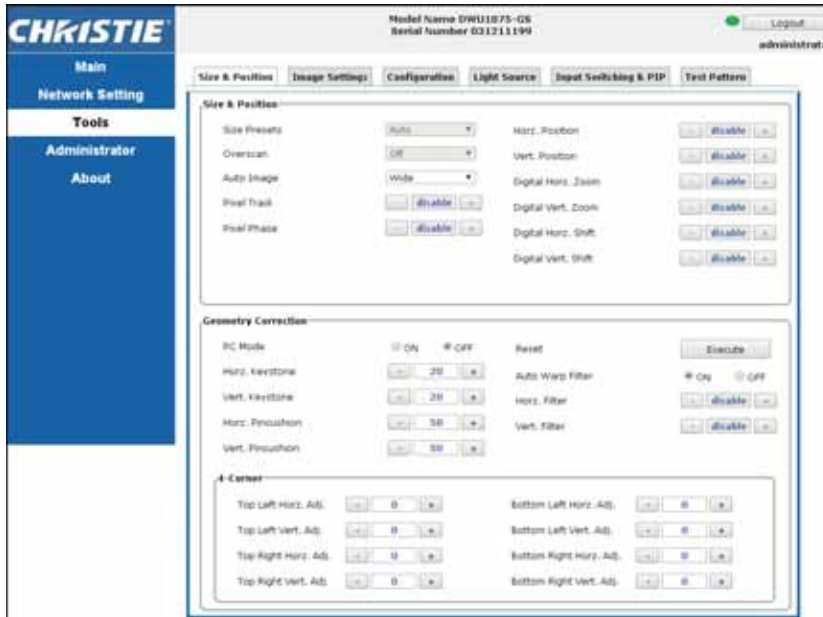

Administrator Page

Add or delete a user or change password.



About Page

The About page provides version and license information about GS Series.



Tab	Description
Version	Views the main firmware version, network firmware version, projector model name, and projector serial number.
License	Displays the license information of the computer program.

Christie Presenter

The Christie Presenter application allows a remote desktop from a host PC to be displayed on the network display through Ethernet or wireless transports. It can adapt to different network settings (DHCP, fixed IP, and direct link by Ethernet cable).

Download Christie Presenter from the Christie website or from the web page of the projector.

Connecting to the Projector

Before using Christie Presenter, you must connect to the projector.

1. Connect to the projector using WiFi or Ethernet.

Ethernet connection:

- a. To determine the projector's IP address, select **Main Menu > Configuration > Communications > LAN**.

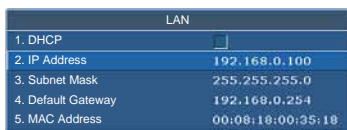

- b. Configure your PC IP address to be on the same network as the projector.
- c. The projector and computer must be connected directly or over the network using Ethernet.

WiFi Wireless connection:

- a. Insert the WiFi USB dongle (1DWUSB-BGN) into the USB port on the projector input panel.

For more information about the WiFi USB dongle, see *Optional accessories* on page 83.

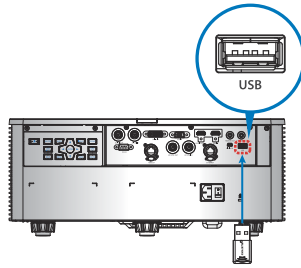

- b. Power on the projector.
- c. Obtain the WiFi SSID from **Main Menu > Configuration > Communications > WLAN**.

- d. Connect your PC device to the wireless SSID for the selected projector, for example: Christie@0111000123.



Installing the Christie Presenter software

Install and configure the Christie Presenter software.

1. In a web browser, connect to the projector's network address.
The default address is 192.168.1.100.
2. Download and install the Christie Presenter software.



3. Configure the Christie Presenter software.



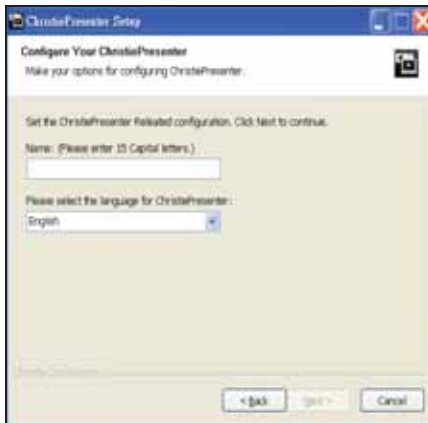



The name entered identifies all computers connected to the projector by the Christie Presenter software—either wired or wireless connections. The **Network Display Management > Device Management** tab shows all current connections.



Using the Christie Presenter

1. After starting the Christie Presenter application, the main window appears.



Icon	Description
	Connects and searches the network display.
	Stops or starts displaying desktop contents to the connected network display.
	Selects a display region.
	Configures Christie Presenter.
	Manages all connected network displays.
	Disconnects all connections.

Connecting and searching the network display

1. To access the Connection menu section, click  .
2. If the IP address of the projector is known, type the IP address and click **Connect**.
3. If the IP address is not known:
 - a. To search for the projector on the network, click **Search**.
 - b. Select the projector to which you want to connect.
 - c. To access the Login dialog, click **Connect directly**.

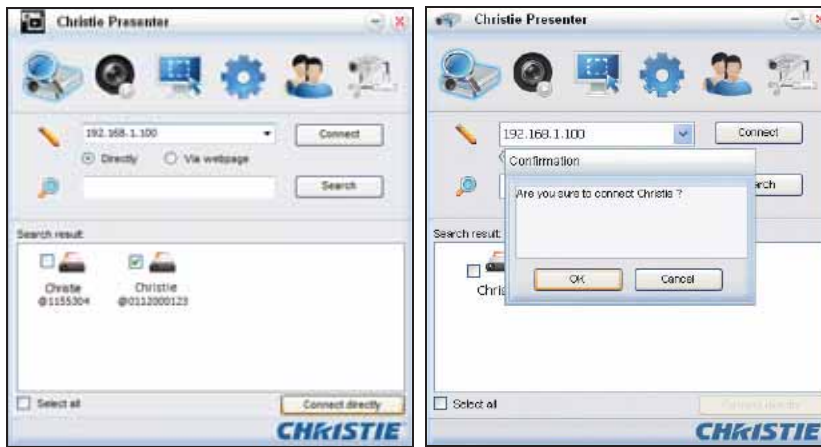

4. In the Login dialog, select the user type and type the password.
 The default password for the Normal user is left blank. If the password was previously set, it appears in the bottom-left corner of the on-screen display. The default password for the Admin user is admin.
5. In the Select display port window, select the display port.

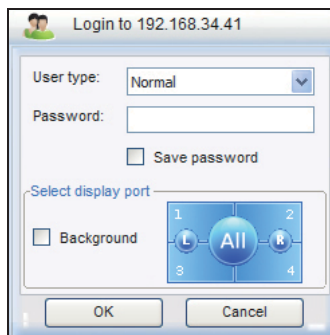

Selecting the display region

When the connection is set up, you must select the display region.

1. To select the size of the projection region, click  and select an option: FullScreen, FixedSize, or Alterable.



Tab	Description
FullScreen	Turns the default capture mode to full screen when the program is launched. If screen capture starts, the image of the entire screen is transferred to a remote network display.
FixedSize	Transfers on the image enclosed inside the frame (after a user places a frame on the desktop) to remote network display.
Alterable	Encloses only the captured region by the frame. To enlarge or downsize the region, drag the eight small black squares scattered on eight edges of the frame.

Configuring Christie Presenter

Set the language for Christie Presenter, the region size of fixed size capture mode, if a notification message dialog is allowed, the quality of JPEG images, YUV sample formats, and the network port setting.

1. To configure Christie Presenter for basic and advanced settings, click  .

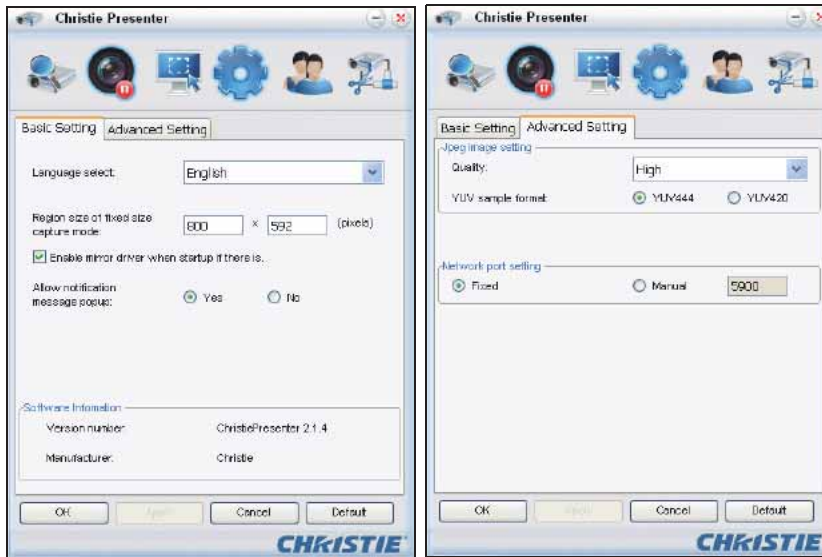









Tab	Description
Basic Setting	Selects the language, changes the region size of fixed size capture mode, and selects if a notification message dialog is allowed.
Advanced Setting	Selects the quality of JPEG image, YUV sample formats and the network port setting. The fixed port is port 5900.

Managing all connected network displays

You can manage all connected network displays and users at the same time.

1. To control all users connected to the same projector, click .



Icon	Description
	Indicates the administrator is logged in.
	Indicates a normal user logged in.
	Indicates the device is connected.
	Indicates the device is not connected.
	Shows the current status and display position of the local screen on the network display. Click to change the display position. A dialog appears.
	Changes the password to the target network display. Only an Administrator user can change the password.
	Does not require a response. If user logs in as Admin, the key icon is displayed and the Presenter password can be changed. If user log in as Normal, the lock icon is displayed and the Presenter password cannot be changed.
	Disconnects from the target network display.
	Connects to a target network display using a web page.

Operating the Card Reader

The Card Reader application has four available operation modes:

- USB Flash Devices Detection screen
- Thumbnail Display mode
- Images Display mode
- Images Slide Show mode

USB Flash Device Detection screen

In this mode, the Card Reader application detects any USB flash devices hot-plug events and displays the flash device icon. When the flash device is removed from USB, the icon disappears. Christie recommends removing the USB flash devices only when the Card Reader is changed to the USB Flash Devices Detection Screen state.



Thumbnail Display mode

1. To access the Thumbnail Display mode, press the **Enter**.
Different photos in different folders can be chosen.
2. To access the Card Reader operation UI, press **Menu**.



3. Operate the Card Reader application with the **Enter**, **Left**, **Right**, **Up**, and **Down** keys.

The following buttons are supported in the user interface:

Button	Description
Previous	Moves the selected item left or goes to previous page when this is the left-most item.

Button	Description
Next	Moves the selected item right or goes to next page when this is the right most item.
Display	Displays the selected image or folder.
Thumbnail	Enter the Thumbnail Display mode.
SlideShow	Enter the Slide Show mode.
NameOrder	Sorts files and folders by name.
ExtendOrder	Sorts files and folders by extended order.
SizeOrder	Sorts files and folders by size.
TimeOrder	Sorts files and folders by time.
EXIF ON/OFF	Enables or disables the auto image rotate accordingly to EXIF information.
FileName ON/OFF	Enables or disables the filename display in Thumbnail Display mode.

Image Display mode

1. In the Thumbnail Display mode, to enter the Image Display mode, press **ENTER**.
2. To display the last or next image in the Image Display mode, use the **Left** and **Right** keys.
3. To exit Image Display mode and return to Thumbnail Display mode, press **ENTER**.



4. To display an image in the Image Display mode use the operation UI.

The following operations are supported in the operation UI.

Button	Description
Display	Enter the Image Display mode.
Thumbnail	Enter the Thumbnail Display mode.
SlideShow	Enter the Slide Show mode.
Actual Size	Displays the image in actual size.
Best Fit	Display the image in a size that best fits the screen.
EXIFDisp OFF/On	Enables or disables the EXIF information display.
+90deg	Rotates the image 90 degrees.
-90deg	Rotates the image -90 degrees.

Image Slide Show mode

1. In the Thumbnail Display mode, to enter the Slide Show mode, press **SlideShow**.
2. In the Slide Show mode, to enter the Image Display Mode, press **ENTER**.
3. To display an image in the Slide Show mode use the operation UI.



The following operations are supported in the Slide Show Mode operation UI.

Button	Description
Stop	Stops Slide Show mode.
Next	Displays the next image.
Previous	Displays the previous image.
Delay 3/4/5	Sets a slide show delay in seconds.
Slide Effect	Supports for the following slide effects: <ul style="list-style-type: none"> • Slide Right • Blocks • RightDown • XLines • Slide Up • Ylines
Repeat ON/OFF	Enables or disables Slide Show Repeat mode.

When the image cannot be displayed due to a memory limitation or an unsupported image format, the specific image is displayed on the center of the screen.

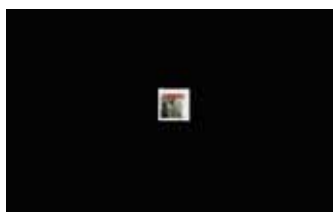

Troubleshooting

If you cannot resolve an issue using the information provided in this section, contact your reseller or service center.

No image appears on screen

The image does not appear on the screen.

Resolution

- Make sure all the cables and power connections are correctly and securely connected.
See [Installation](#) on page 19 for more details.
- Make sure the projector is switched on.

Incorrectly displayed image

The image is partial, is scrolling, or is otherwise incorrectly displayed.

Resolution

If using a PC (for Windows 95, 98, 2000, XP, Windows 7):

1. On control panel or IR remote keypad, press **AUTO**.
2. Select **My Computer > Control Panel**.
3. Double-click **Display**.
4. Select the **Settings** tab.
5. Verify your display resolution setting is lower than or equal to WUXGA (1920 × 1200).
6. Click **Advanced Properties**.
7. If the projector is still not projecting the entire image, change the monitor display:
 - a. Verify the resolution setting is lower than or equal to WUXGA (1920 × 1200).
 - b. Switch to the **Monitor** tab.
 - c. Click **Change**.

- d. Click **Show all devices**.
- e. Under the SP box, select **Standard monitor types**.
- f. Under the Models box, select the appropriate resolution mode.
- g. Verify that the resolution setting of the monitor display is lower than or equal to WUXGA (1920 × 1200).

If using a Notebook:

1. On control panel or IR remote keypad, press **AUTO**.
2. Adjust resolution of the computer.
3. To send signal out from notebook to projector, press the keys listed below for your Notebook manufacturer (for example, [Fn] + [F4]):

Notebook brand	Function keys
Acer	[Fn] + [F5]
Asus	[Fn] + [F8]
Dell	[Fn] + [F8]
Gateway	[Fn] + [F4]
IBM/Lenovo	[Fn] + [F7]
HP/Compaq	[Fn] + [F4]
NEC	[Fn] + [F3]
Toshiba	[Fn] + [F5]
Mac Apple	System Preference > Display > Arrangement > Mirror display

4. If you experience difficulty changing resolutions or your monitor freezes, restart all equipment including the projector.

Presentation is not displayed

The screen of the Notebook or PowerBook computer is not displaying your presentation.

Details

Some Notebook PCs may deactivate their own screens when a second display device is in use. Each has a different method of reactivation.

Resolution

Refer to your computer manual for information on changing the method of reactivation.

Unstable or flickering images

The image is unstable or is flickering when projected.

Resolution

- To correct the pixels, use Pixel Track and Pixel Phase.
- Change the monitor color setting on your computer.

Vertical flickering bar

The image has a vertical, flickering bar when projected.

Resolution

- To make an adjustment, use **Auto Image**.
- Check and reconfigure the display mode of your graphic card to make it compatible with the projector.

Image is out of focus

The image is out of focus on the screen.

Resolution

- Make sure both lens caps (front and back) are removed.
- Adjust the lens focus to fit the screen.
- Make sure the projection screen is between the required distance.

Image is stretched

The image is stretched when displaying a 16:9 DVD title.

Details

When you play anamorphic DVD or 16:9 DVD, the projector shows the best image if the projector display mode is set to 16:9 in the on-screen display.

Resolution

- If you play 4:3 format DVD titles, change the format to 4:3 in the projector on-screen display.
- If the image is still stretched, adjust the aspect ratio by setting the display format as 16:9 (wide) aspect ratio type on your DVD player. For more details, see [Size and Position menu](#) on page 31.

Image is not the correct size

The image is too small or too large.

Resolution

- Adjust the lens zoom to fit.
- Verify you are using the correct lens.
- Change the position of the projector.

Specifications

Learn about the product specifications. Due to continuing research, specifications are subject to change without notice.

Inputs

The following table details the inputs for GS Series. RB in the Resolution column indicates reduced blanking.

Signal Type	Resolution	Frame rate (Hz)	QD881	VGA	HDMI	DVI	HDBaseT	3G-SDI
PC	640x480	60	DMT0660	•	•	•	•	
	640x480	72	DMT0672	•	•	•	•	
	640x480	75	DMT0675	•	•	•	•	
	640x480	85	DMT0685	•	•	•	•	
	640x480	66.6	APP0667		•	•	•	
	720x400	70	IBM0770H	•	•	•	•	
	800x600	60	DMT0860	•	•	•	•	
	800x600	72	DMT0872	•	•	•	•	
	800x600	75	DMT0875	•	•	•	•	
	800x600	85	DMT0885	•	•	•	•	
	800x600	120	CVR0812	•	•	•	•	
	832x624	75	8362A75	•	•	•	•	
	848x480	50	CVT0850H		•	•	•	
	848x480	60	CVT0860H		•	•	•	
	848x480	75	CVT0875H		•	•	•	
	848x480	85	CVT0885H		•	•	•	
	1024x768	60	DMT1060	•	•	•	•	
	1024x768	75	DMT1075	•	•	•	•	
	1024x768	85	DMT1085	•	•	•	•	
	1024x768	120	CVR1012	•	•	•	•	
	1152x720	50	CVT1150D		•	•	•	
	1152x720	60	CVT1160D		•	•	•	
	1152x720	75	CVT1175D		•	•	•	

Signal Type	Resolution	Frame rate (Hz)	QD881	VGA	HDMI	DVI	HDBaseT	3G-SDI
PC	1152x720	85	CVT1185D		•	•	•	
	1152x864	60	CVT1160	•	•	•	•	
	1152x864	70	DMT1170	•	•	•	•	
	1152x864	75	DMT1175	•	•	•	•	
	1152x864	85	DMT1185	•	•	•	•	
	1152x870	75	APP1175		•	•	•	
	1280x720	50	CVT1250H		•	•	•	
	1280x720	60	CVT1260H	•	•	•	•	
	1280x720	75	CVT1275H	•	•	•	•	
	1280x720	85	CVT1285H	•	•	•	•	
	1280x720	120		•	•	•	•	
	1280x768	60	CVT1260E	•	•	•	•	
	1280x768	75	CVT1275E	•	•	•	•	
	1280x768	85	CVT1285E	•	•	•	•	
	1280x800	50	CVT1250_	•	•	•	•	
	1280x800	60	DMT1260D	•	•	•	•	
	1280x800	75	CVT1275_	•	•	•	•	
	1280x800	85	CVT1285_	•	•	•	•	
	1280x960	50	CVT1250		•	•	•	
	1280x960	60	CVT1260	•	•	•	•	
	1280x960	75	CVT1275	•	•	•	•	
	1280x960	85	CVT1285	•	•	•	•	
	1280x1024	50	CVT1250G		•	•	•	
	1280x1024	60	DMT1260G	•	•	•	•	
	1280x1024	75	DMT1275G	•	•	•	•	
	1280x1024	85	DMT1285G	•	•	•	•	
	1360x768	50	CVT1350H		•	•	•	
	1360x768	60	DMT1360H		•	•	•	
	1360x768	75	CVT1375H		•	•	•	
	1360x768	85	CVT1385H		•	•	•	
	1368x768	60	DMR1360H	•	•	•	•	
	1400x1050	50	CVT1450		•	•	•	
	1400x1050	60	CVT1460		•	•	•	
	1400x1050	75	CVT1475	•	•	•	•	

Signal Type	Resolution	Frame rate (Hz)	QD881	VGA	HDMI	DVI	HDBaseT	3G-SDI
PC	1440x900	60	CVT1460D	•	•	•	•	
	1440x900	75	CVT1475D		•	•	•	
	1600x900	60	DMR1660H		•	•	•	
	1600x1200	60	DMT1660	•	•	•	•	
	1680x1050	60	CVT1660D	•	•	•	•	
	1920X1080	50	CVR1950H		•	•	•	
	1920X1080	60	CVR1960H	•	•	•	•	
	1920X1200R B	60	CVT1660D	•	•	•	•	
	1920X1200R B	50	CVR1960D	•	•	•	•	
NTSC	NTSC (M, 4.43)	60						
PAL	PAL (B,G,H,I)	50						
	PAL (N)	50						
	PAL (M)	60						
SECAM	SECAM (M)	50						
SDTV	480i	60		•	•	•	•	
	576i	50		•	•	•	•	
EDTV	480p	60		•	•	•	•	
	576p	50		•	•	•	•	

Signal Type	Resolution	Frame rate (Hz)	QD881	VGA	HDMI	DVI	HDBaseT	3G-SDI
HDTV	1080i	25		•	•	•	•	
	1080i	29		•	•	•	•	
	1080i	30		•	•	•	•	
	720p	50		•	•	•	•	
	720p	59		•	•	•	•	
	720p	60		•	•	•	•	
	1080p	23		•	•	•	•	
	1080p	24		•	•	•	•	
	1080p	25		•	•	•	•	
	1080p	29		•	•	•	•	
	1080p	30		•	•	•	•	
	1080p	50		•	•	•	•	
	1080p	59		•	•	•	•	
	1080p	60		•	•	•	•	
Mandatory 3D	Frame Packing 1080p	24			•		•	
	Frame Packing 720p	50			•		•	
	Frame Packing 720p	60			•		•	
	Side by Side 1080i	50			•		•	
	Side by Side 1080i	60			•		•	
	Top and Bottom 720p	50			•		•	
	Top and Bottom 720p	60			•		•	
	Top and Bottom 1080p	24			•		•	

Signal Type	Resolution	Frame rate (Hz)	QD881	VGA	HDMI	DVI	HDBaseT	3G-SDI	
Frame sequential 3D	800x600	120			•		•		
	1024x768	120			•		•		
	1280x720	120			•		•		
	1080p	50			•		•		
	1080p	60			•		•		
	1920X1200R B	50			•		•		
	1920X1200R B	60			•		•		
SD-SDI	480i YCbCr422 10bit	59.94						•	
	576i YCbCr422 10bit	50						•	
HD-SDI	720p YCbCr422 10bit	50						•	
		59.94						•	
		60						•	
	1080i YCbCr422 10bit	50							•
		59.94							•
		60							•
	1080p YCbCr422 10bit	23.98							•
		24							•
		25							•
		29.97							•
		30							•
	1080sF YCbCr422 10bit	25							•
		29.97							•
		30							•
	3GA-SDI	1080p YCbCr422 10bit	50						•
59.94								•	
60								•	
3GB-SDI	1080p YCbCr422 10bit With 352M Payload ID	50							
		59.94						•	
		60						•	

PIP/PBP compatibility

The following table details the PIP/PBP compatibility.

PIP/PBP Matrix	3G-SDI	VGA	DVI	HDMI 1	HDMI 2	HDBaseT RJ45-1	USB A	Mini USB	Ethernet RJ45-2
3G-SDI	-	-	-	•	•	•	•	•	•
VGA	-	-	-	•	•	•	•	•	•
DVI	-	-	-	•	•	•	•	•	•
HDMI1	•	•	•	-	-	-	-	-	-
HDMI2	•	•	•	-	-	-	-	-	-
HDBaseT RJ45-1	•	•	•	-	-	-	-	-	-
USB A	•	•	•	-	-	-	-	-	-
Mini USB	•	•	•	-	-	-	-	-	-
Ethernet RJ45-2	•	•	•	-	-	-	-	-	-

- Dot (•): PIP/PBP combinations are enabled.
- Dash (-): PIP/PBP combinations are disabled.

Key features

- HD 0.65" 1920 × 1080 resolution or WUXGA 0.67" 1920 × 1200 resolution
- Projection lens compatibility:
 - Horizontal offset ranges with half image size: +/-30%
 - Vertical offset ranges with half image size: +/-100% (WUXGA) and +/-120% (HD)
Measurements comply with industry standards where offset is calculated as a ratio of the number of pixels shifted up or down to half image size.
 - 360 degree orientation
 - 3D blending and auto warping
- Wireless desktop display using wireless dongle (optional)
- SNMP traps and email notifications
- 10-bit image processor electronics with modular design
- All video formats can be resized to full screen either horizontally or vertically while maintaining aspect ratio
- The projector can be operated using any of the following:
 - The built-in keypad, the infrared (IR) remote keypad, a wired remote keypad, a PC/ device using serial communications (Ethernet or RS232)
 - A web page using Ethernet or from a PC or device using a wireless USB dongle (optional)

List of components

This projector comes with all the items listed below. Check to make sure your package is complete. If anything is missing, contact your dealer.

- IR remote keypad (P/N: 003-004468-XX)
- Power cords supplied with the projector:
 - UK
 - North America
 - Europe, Korea, and Russia
 - Japan
 - India
 - South Africa
 - Australia and New Zealand
- User manual (USB)

Due to the difference in applications for each country, some regions may have different accessories.

Optional accessories

The following accessories are available for the projector:

- Lens Zoom G 0.75-0.95 (A15) (P/N: 140-119102-XX)
- Lens Zoom G 0.95-1.22 (A01) (P/N: 140-101103-XX)
- Lens Zoom G 1.52-2.89 (A03) (P/N: 140-102104-XX)
- Lens Zoom G 2.90-5.50 (A13) (P/N: 140-107109-XX)
- Lens Zoom G 1.22-1.52 (A06) (P/N: 140-131106-XX)
- Cable Cover (White) (P/N: 140-106108-XX)
- WIFI Adapter (P/N: 133-113106-XX)
- Portrait Side Cover (White) (P/N: 140-108100-XX)
- Christie One Mount (P/N: 108-506102-XX)
- One Mount Extender Rod (P/N: 121-125109-XX)
- Christie QwikRig Rigging Frame (P/N: 140-128102-XX)
- One Mount Rigging Kit (P/N: 121-126100-XX)
- Lens UST 0.36:1 (A16) (P/N: 140-133108-XX)

Physical specifications

Learn the dimensions and weight of the projector.

Description	Dimensions
Projector size	
Overall size (L x W x H) (excluding lens, feet)	480 mm (19.2") x 555 mm (22.2") x 190 mm (7.6")
Overall size, shipping without lens (L x W x H) (includes packaging)	599 mm (24.07") x 759 mm (30.4") x 373 mm (14.9")
Projector Weight	
Without lens	24.9 kg (54.9 lbs)
Shipping without lens (includes packaging)	31.7 kg (69.9 lbs)
Operating position	
360 degrees front to back and portrait capable	Free orientation and no tilt range constraint

Physical operating environment

Provides specifications for the operating environment.

- Operating: 0°C to 40°C
 - 0 to 40°C (0 to 2500 ft)
 - 0 to 35°C (2500 to 5000 ft)
 - 0 to 30°C (5000 to 10000 ft)
- Storage temperature range: -10°C to 60°C
- Humidity range: 10% to 85% RH (maximum), non condensing
- Storage humidity range: 5% to 90% RH (maximum), non condensing
- Operating altitude: 10,000 ft maximum

Power requirements

Learn the power requirements for the projector.

Parameter	Requirement
Rated voltage	100V-240V
Rated current	
DHD1075-GS/DWU1075-GS	10A
Line frequency	50/60Hz
AC input coupler	C14
Inrush current	80A max
Maximum power consumption	1070W

Warnings

If the end-user presses the source key on the IR remote keypad that is not supported, for example **BNC(2)**, the projector displays the following warning:



Not supported

Regulatory

This product conforms to the following regulations related to product safety, environmental requirements and electromagnetic compatibility (EMC).

Safety

- CSA C22.2 No. 60950-1
- UL 60950-1
- IEC 60950-1
- EN 60950-1

Laser safety

- IEC 60825-1
- IEC 62471
- FDA CDRH CFR 1040.10
- FDA CDRH CFR 1040.11

Electro-Magnetic Compatibility

Emissions

- FCC CFR47, Part 15, Subpart B/ANSI C63.4, Class A - Unintentional Radiators
- CISPR32/EN55032 Class A - Information Technology Equipment
- ICES/NMB003 (A) - Information Technology Equipment

Immunity

- CISPR 24/EN55024 EMC Requirements - Information Technology Equipment

Environmental

- The product conforms to:
 - EU Directive (2011/65/EU) on the restriction of the use of certain hazardous substances (RoHS) in electrical and electronic equipment and the applicable official amendment(s).
 - EU Regulation (EC) No. 1907/2006 on the registration, evaluation, authorization and restriction of chemicals (REACH) and the applicable official amendment(s).
 - EU Directive (2012/19/EU) on waste and electrical and electronic equipment (WEEE) and the applicable official amendment(s).
 - China Ministry of Information Industry Order No.39 (02/2006) on the control of pollution caused by electronic information products, the hazardous substances concentration limits (SJ/T11363-2006), and the applicable product marking requirement (SJ/T11364-2006).

Federal Communications Commission (FCC) warning

- Only use the supplied power cord.

On-screen display tree

The following table provides the on-screen display menu tree.

Level 1	Level 2	Level 3 (Or List)	Level 4 (Or List)	Level 5 (Or List)	Level 6 (Or List)	Default
Size & Position	Size Presets	Auto				Auto
		Native				
		4:3				
		Letterbox				
		Full Size				
		Full Width				
		Full Height				
		Custom				
		3D Mode				
	Overscan	Off				Set by different source
		Zoom				
		Crop				
	Pixel Track	0 to 100				50
	Pixel Phase	0 to 100				50
	Horz Position	0 to 100				50
	Vert Position	0 to 100				50
	Digital Horz Zoom	50% to 400%				100
Digital Vert Zoom	50% to 400%				100	
Digital Horz Shift	0 to 100				50	
Digital Vert Shift	0 to 100				50	
Geometry Correction	PC Mode	On/Off			Off	

Level 1	Level 2	Level 3 (Or List)	Level 4 (Or List)	Level 5 (Or List)	Level 6 (Or List)	Default		
Size & Position	Geometry Correction	Warp	Keystone	Horz Keystone	0 to 40	20		
				Vert Keystone	0 to 40	20		
			Pincushion	Horz Pincushion	0 to 100	50		
				Vert Pincushion	0 to 100	50		
			4-Corner	Top Left Horz Adjust	0 to 120 (pixel)	0		
				Top Left Vert Adjust	0 to 80 (pixel)	0		
				Top Right Horz Adjust	0 to 120 (pixel)	0		
				Top Right Vert Adjust	0 to 80 (pixel)	0		
				Bottom Left Horz Adjust	0 to 120 (pixel)	0		
				Bottom Left Vert Adjust	0 to 80 (pixel)	0		
				Bottom Right Horz Adjust	0 to 120 (pixel)	0		
				Bottom Right Vert Adjust	0 to 80 (pixel)	0		
			Auto Warp Filter	Off/On		On		
			Horz Filter	0 to 9				
			Vert Filter	0 to 9				
			Reset	Command				
			Auto Image	Normal				Wide
				Wide				

Level 1	Level 2	Level 3 (Or List)	Level 4 (Or List)	Level 5 (Or List)	Level 6 (Or List)	Default	
Image settings	Brightness	0 to 100				50	
	Contrast	0 to 100				Set by different source	
	Color Space	Auto					Auto
		RGB	RGB Full				RGB Full
			RGB Limited				
			REC709				
		YUV	REC709				REC709
	REC601						
	Detail	Maximum					Normal
		High					
		Normal					
		Low					
		Minimum					
	3D Display	3D Enable	Auto				Auto
			Frame Packing				
			Side by Side				
			Top and Bottom				
			Frame Sequential				
			Off				
		3D Invert	Off				Off
			On				
		Toggle 3D Blending	Enter key				N/A
		3D Sync Out	To Emitter				To Emitter
To Next Projector							
Frame Delay	1 ~ n (by timing, Max 200)				1		
Video Options	Color	0 to 100				50	
	Tint	0 to 100				50	
	Detect Film	Off				Off	
		On					

Level 1	Level 2	Level 3 (Or List)	Level 4 (Or List)	Level 5 (Or List)	Level 6 (Or List)	Default	
Image settings	Input Levels	Red Gain	0 to 100			50	
		Green Gain	0 to 100			50	
		Blue Gain	0 to 100			50	
		Red Offset	0 to 100			50	
		Green Offset	0 to 100			50	
		Blue Offset	0 to 100			50	
		Sync Threshold	0 to 100			50	
		Reset RGB Gain/ Offset	Command				
	Picture Settings	Presentation					Set by different source
		Video					
		Bright					
		Enhanced					
		REC709					
		Real					
		DICOM SIM					
		2D High Speed					
		3D					
		Blending					
		User					
	Save to User	command					
	Contrast Enhancement	Off					Off
		DynamicBlack™					
		RealBlack					
Image Freeze	Off					Off	
	On						

Level 1	Level 2	Level 3 (Or List)	Level 4 (Or List)	Level 5 (Or List)	Level 6 (Or List)	Default
Image settings	Advanced Image Settings	Gamma	Video			Set by different source
			Film			
			Bright			
			CRT			
			DICOM			
		White Peaking	0 to 100			Set by different source
		Color Temperature	Warmest			Set by different source
			Warm			
			Cool			
		Edge Enhancement	Off			Off
			Normal			
			Maximum			
		Color Wheel Speed	2X			3X
3X						
Configuration	Language	SPEC define				English
	Lens Settings	Focus	Command			
		Zoom	Command			
		Lens Shift	Command			
		Lens Shift Memory	Apply Position	1 to 5		1
			Save Current Position	1 to 5		
		Lock All Lens Motors	Allow			Allow
			Locked			
	Lens Calibration	Command				
	Ceiling Mount	Off				Auto
		On				
		Auto				
	Rear Projection	Off				Off
		On				

Level 1	Level 2	Level 3 (Or List)	Level 4 (Or List)	Level 5 (Or List)	Level 6 (Or List)	Default
Configuration	Menu Preferences	Menu Horz Offset	0 to 100			0
		Menu Vert Offset	0 to 100			0
		Show Messages	Off			On
			On			
		Menu Transparency	0 to 90			0
		Splash Screen Setup	Factory Logo			Factory Logo
			Blue			
			Black			
			White			
		PIN Protect	Command			
	Change PIN	Command				
	Power Management	Standby Mode	0.5W Mode			Communication Mode
			Communication Mode			
		AC Power On	Off			Off
			On			
		Auto Shutdown	Never			Never
			5 Mins			
			10 Mins			
			15 Mins			
			20 Mins			
			25 Mins			
			30 Mins			
		Sleep Timer	Off			Off
			2 Hrs			
			4 Hrs			
			6 Hrs			
		Cool Down	Instant Off			Instant Off
1 Min						
2 Min						
High Altitude	Off			Off		
	On					

Level 1	Level 2	Level 3 (Or List)	Level 4 (Or List)	Level 5 (Or List)	Level 6 (Or List)	Default	
Configuration	IR Control	Top	Off			On	
			On				
		Front	Off			On	
			On				
		HDBaseT	Off			On	
			On				
	Communications	LAN	LAN	DHCP			Set by user
				IP Address			
				Subnet Mask			
				Default Gateway			
				MAC Address			
		WLAN	WLAN	Enable			Set by user
				Start IP			
				End IP			
				Subnet Mask			
				Default Gateway			
				MAC Address			
				SSID			
		Network	Network	Projector Name			Set by user
				Show Network Messages			
				Restart Network			Set by user
				Network Factory Reset			
		Serial Port Baud Rate	Serial Port Baud Rate	2400			115200
				4800			
				9600			
				14400			
				19200			
				38400			
57600							
115200							
1200							

Level 1	Level 2	Level 3 (Or List)	Level 4 (Or List)	Level 5 (Or List)	Level 6 (Or List)	Default	
Configuration	Communications	Serial Port Echo	Off			Off	
			On				
		Serial Port Path	RS232			RS232	
			HDBaseT				
		Projector Address	0 to 9			0	
		Backlight Preferences	Keypad Backlight	Timeout 5 Secs			Timeout 5 Secs
	Timeout 10 Secs						
	Timeout 20 Secs						
	Timeout 30 Secs						
	Always On						
	Always Off						
	Status LED		Always On			Always On	
			Always Off				
			Warnings/Errors Only				
	Color Matching	Manual Adjustment	Enable	On			Off
				Off			
			Auto Test Pattern	On			On
				Off			
			Red Part of Red	0 to 1000			1000
			Green Part of Red	0 to 1000			0
			Blue Part of Red	0 to 1000			0
			Green Part of Green	0 to 1000			1000
			Red Part of Green	0 to 1000			0
			Blue Part of Green	0 to 1000			0
			Blue Part of Blue	0 to 1000			1000
			Red Part of Blue	0 to 1000			0
			Green Part of Blue	0 to 1000			0

Level 1	Level 2	Level 3 (Or List)	Level 4 (Or List)	Level 5 (Or List)	Level 6 (Or List)	Default	
Configuration	Color Matching	Manual Adjustment	Red Part of White	0 to 1000		1000	
			Green Part of White	0 to 1000		1000	
			Blue Part of White	0 to 1000		1000	
			Reset to Default	Yes			
		No					
		HSG Adjustment	HSG Enable	On			Off
				Off			
			Auto Test Pattern	On			On
				Off			
			Red	Hue	0 to 254	127	
				Saturation	0 to 254	127	
				Gain	0 to 254	127	
			Green	Hue	0 to 254	127	
				Saturation	0 to 254	127	
				Gain	0 to 254	127	
			Blue	Hue	0 to 254	127	
				Saturation	0 to 254	127	
				Gain	0 to 254	127	
			Cyan	Hue	0 to 254	127	
				Saturation	0 to 254	127	
				Gain	0 to 254	127	
			Magenta	Hue	0 to 254	127	
				Saturation	0 to 254	127	
				Gain	0 to 254	127	
			Yellow	Hue	0 to 254	127	
				Saturation	0 to 254	127	
				Gain	0 to 254	127	
			White Gain	Red	0 to 254	127	
				Green	0 to 254	127	
				Blue	0 to 254	127	
			Reset to Default	Yes			
				No			

Level 1	Level 2	Level 3 (Or List)	Level 4 (Or List)	Level 5 (Or List)	Level 6 (Or List)	Default
Configuration	Color Matching	HSG Adjustment	Color Enhance	Off		CE1
				CE 1		
				CE 2		
		Wall Color	White			White
		Gray 130				
	Hot Key Settings	Blank Screen				
		Aspect Ratio				
		Freeze Screen				
		Projector Info				
		Overscan				
	Service	Projector Info	Model Name			
			Serial Number			
			Native Resolution			
			MCU Version			
			Scaler Version			
			3D Decoder Version			
			Formatter Version			
			HDBaseT Version			
			Keypad Version			
			LD Driver Version			
Lan Version						
Standby Mode						
Lens Lock Settings						
Wheel Index						
Factory Reset	Command					

Level 1	Level 2	Level 3 (Or List)	Level 4 (Or List)	Level 5 (Or List)	Level 6 (Or List)	Default	
Configuration	Service	Test Pattern	Off				
			Grid				
			White				
			Black				
			Checkerboard				
			Color Bars				
			Red				
			Green				
			Blue				
			Yellow				
			Magenta				
			Cyan				
			Boresight				
			Full Screen				
		Wheel Index (2X)	Phosphor Index	0 to 719			
			Filter Index	0 to 719			
		Wheel Index (3X)	Phosphor Index	0 to 719			
			Filter Index	0 to 719			
		Error Log	Show Log				
			Clear Log				
		Mode Adjustment					
		Laser Diode Info	LD1				Voltage/ Current/ Temperature
			LD2				Voltage/ Current/ Temperature
			LD3				Voltage/ Current/ Temperature
			LD4				Voltage/ Current/ Temperature
			LD5				Voltage/ Current/ Temperature

Level 1	Level 2	Level 3 (Or List)	Level 4 (Or List)	Level 5 (Or List)	Level 6 (Or List)	Default
Configuration	Service	Laser Diode Info	LD6			Voltage/ Current/ Temperature
			LD7			Voltage/ Current/ Temperature
			LD8			Voltage/ Current/ Temperature
			LD9			Voltage/ Current/ Temperature
		Fan Info	Fan1			RPM
			Fan2			RPM
			Fan3			RPM
			Fan4			RPM
			Fan5			RPM
			Fan6			RPM
			Fan7			RPM
			Fan8			RPM
			Fan9			RPM
			Fan10			RPM
		ADC Calibration	Calibration Condition			
			ADC Calibration			
		Light Sensor	Light Sensor Info			
			Calibration			
		Burn in	Off			
			60/10/2			
			60/10/4			
			60/10/6			
		UST Lens Install	Confirm			
			Install			
			Test Pattern 1			
			Test Pattern 2			
			Test Pattern 3			
			Test Pattern 4			

Level 1	Level 2	Level 3 (Or List)	Level 4 (Or List)	Level 5 (Or List)	Level 6 (Or List)	Default	
Configuration	Service	UST Lens Install	Finished				
			Cancel				
Light Source	Light Source Mode	Constant Power				Constant Power	
		Constant Intensity					
		ECO 1 (80%)					
		ECO 2 (50%)					
		Rental Mode (90%)					
	Constant Power	0 to 99 (30% to 100%)				99	
	Light Source Info	Total Projector Hours					
		LD Hours					
	Light Sensor Calibration	Default					Default
		Auto					
Manual							
Status	Model Name						
	Serial Number						
	Native Resolution						
	Firmware					Vxx, Ayy, Bzz	
	Main Input						
	Main Signal Format						
	Main Pixel Clock						
	Main Sync Type						
	Main Horz Refresh						
	Main Vert Refresh						
	PIP/PBP Input						
	PIP/PBP Signal Format						
	PIP/PBP Pixel Clock						
	PIP/PBP Sync Type						

Level 1	Level 2	Level 3 (Or List)	Level 4 (Or List)	Level 5 (Or List)	Level 6 (Or List)	Default	
Status	PIP/PBP Horz Refresh						
	PIP/PBP Vert Refresh						
	Light Source Power						
	Total Projector Hours						
	Light Source Hours					BLD/RLD	
	LC Hours						
	Standby Mode						
	Lens Lock Settings						
	IP Address						
	DHCP						
	System Temperature						
Input Switching & PIP	Main Input	SPEC define					
	PIP/PBP Input	SPEC define					
	PIP/PBP Enable	Off					Off
		On					
	Swap						
	Size	(Small/Medium/Large)					
	Main Layout	(PBP, Main Left/ PBP, Main Top/ PBP, Main Right/ PBP, Main Bottom/PIP-Bottom Right/ PIP-Bottom Left/ PIP-Top Left/ PIP-Top Right)					
Timing Detection Mode	Normal					Wide	
	Wide						

Level 1	Level 2	Level 3 (Or List)	Level 4 (Or List)	Level 5 (Or List)	Level 6 (Or List)	Default	
Input Switching & PIP	Source Info	Active Source					
		Signal Format					
		Aspect Ratio					
		Resolution					
		Vert Refresh					
		Horz Refresh					
		Pixel Clock					
		Sync Type					
		Color Space					
		PIP/PBP (When PIP/PBP active)					
		<PIP/PBP source lines> (When PIP/PBP active)					
	Input key	Change Sources					Auto Source
		List All Sources					
		Auto Source					
Blank on Signal Switch	Off					Off	
	On						
Language	SPEC define					English	
Test pattern	Off						
	Grid						
	White						
	Black						
	Checkerboard						
	Color Bars						

Corporate offices

USA – Cypress
ph: 714-236-8610

Canada – Kitchener
ph: 519-744-8005

Consultant offices

Italy
ph: +39 (0) 2 9902 1161

Worldwide offices

Australia
ph: +61 (0) 7 3624 4888

Brazil
ph: +55 (11) 2548 4753

China (Beijing)
ph: +86 10 6561 0240

China (Shanghai)
ph: +86 21 6278 7708

Eastern Europe and
Russian Federation
ph: +36 (0) 1 47 48 100

France
ph: +33 (0) 1 41 21 44 04

Germany
ph: +49 2161 664540

India
ph: +91 (080) 6708 9999

Japan
ph: 81-3-3599-7481

Korea (Seoul)
ph: +82 2 702 1601

Republic of South Africa
ph: +27 (0)11 510 0094

Singapore
ph: +65 6877-8737

Spain
ph: + 34 91 633 9990

United Arab Emirates
ph: +971 4 3206688

United Kingdom
ph: +44 118 977 8000



For the most current technical documentation,
please visit www.christiedigital.com

CHRISTIE®